



# Roadtrek™®

The Motorhome that...  
*Drives like an SUV!*™®



## 170 & 190 Chevrolet Models Owner's Manual

Including  
Limited Warranty Information





# WARNINGS AND CAUTIONS

This manual contains **WARNINGS** against operating procedures which could result in an accident or bodily injury.

The manual also contains **CAUTIONS** against procedures which could result in damage to your vehicle.

If you do not read the entire manual you may miss important information. Observe all Warnings & Cautions.

**WARNINGS:**

---

**SEAT BELTS:**

Only forward facing seats equipped with factory installed seat belts are to be occupied while the vehicle is in motion. All passengers must be seated in these seats only, with the seat belts fastened while the vehicle is in motion.

**Propane:**

Propane tanks shall not be placed or stored inside your vehicle. Propane tanks are equipped with safety devices which relieve excessive pressure by discharging gas to the atmosphere.

To reduce the danger of fire or explosion do not store gasoline or other flammable liquids inside your vehicle. Ensure you purchase propane from a reputable propane facility. Contaminated propane is common cause of system failure.

Do not refuel the propane tank to more than 80% of its capacity.

The propane tank valve must be closed and ALL PILOT LIGHTS, APPLIANCES, AND THEIR IGNITERS (see Operating Instructions) SHALL BE TURNED OFF during refueling of motor fuel tank and/or the propane tank. Only qualified personnel should refuel your propane tank.

**APPLIANCES:**

It is not safe to use cooking appliances for space heating purposes due to the danger of asphyxiation.

The propane stove needs fresh air for its safe operation.

Portable fuel burning equipment, including wood or charcoal grills and stoves, should not be used inside your vehicle. Use of this type of equipment inside your vehicle may cause fire or asphyxiation.

**PROPANE LEAK DETECTOR:**

Do not block air circulation in the area where the Propane Leak Detector is located.

Battery disconnect switch must be in the "ON" position for the propane detector to function.

**CARBON MONOXIDE LEAK DETECTOR:**

Do not block air circulation in the area where the carbon monoxide leak detector is located.

Battery disconnect switch must be in the "ON" position for the Carbon Monoxide Leak Detector to function.

**110 VOLT ELECTRICAL SERVICING:**

Prior to servicing the 110 volt Galley GFCI & Audio/Video cabinet interior receptacles, unplug the output lead from the power inverter.

**EXTERIOR ACCESS DOORS:**

Ensure power cord and city water line are disconnected and in their stored positions before vehicle is put in motion.

**CAUTIONS:**

---

**CLOVERLEAF DINING TABLE:**

Cloverleaf dining table is heavy, lift while bending knees.

**EXTRA COUNTER SPACE:**

Make sure the stove is off and has cooled prior to lowering the stove cover.

**TV:**

When the vehicle is in motion it is recommended that the TV be "OFF" and in the stored position. The thumb tab should be in place to secure the TV in the stored position.

The flat screen TV (option TF) should not be stored inside the Roadtrek in temperatures below -4°F (-20°C). The operating temperature of the monitor is recommended between 50°F & 104°F (10°C – 40°C) with a humidity range of 10%-80%, non condensing.

To remove the T/V, remove the four mounting bolts on the back of the T/V mounting bracket and remove the RCA cables, power supply cable and antenna cable.

**AUXILIARY BATTERY:**

Battery acid can burn skin and clothing. Protective eye wear and gloves should be worn when handling batteries.

**REPLACING THE AUXILIARY BATTERY:**

Ensure that the inverter is disconnected prior to disconnecting the auxiliary battery.

**GENERATOR:**

When launching a boat, using your Roadtrek, it is important to know that the generator must not be submerged in water.

**WASTE WATER STORAGE AND DUMPING SYSTEM:**

Ensure that both the black and gray water gate valves are closed (inward position) before using the waste water system.

Under moderate subfreezing conditions, antifreeze is required in the exterior fresh water tank, black and gray waste water tanks. Antifreeze should be used at a 50% water and 50% antifreeze ratio.

**THE WARNINGS AND CAUTIONS IN THE QUICK REFERENCE ARE AN OVERVIEW AND THERE ARE MORE NOTES AND INSTRUCTIONS WITHIN THIS MANUAL.**

2005 Standard and Optional Automotive Features	Roadtrek 170 models on Chevrolet 2500 Regular Van	Roadtrek 190 models on Chevrolet 3500 Extended Van
Air bag - driver & passenger	standard with passenger on/off switch	standard with passenger on/off switch
Alternator	145 amp.	145 amp.
Axle - rear - standard	3.73 ratio	4.10 ratio
Axle - rear - optional	not available	4.10 ratio (w/locking diff., trans. cooler)
Battery	600 amp.	600 amp.
Brakes - anti lock	four wheel disc	four wheel disc
Bumper covers	incl. with ground effects package	incl. with ground effects package
Cooling - transmission oil	standard - internal	standard - internal
Defroster - rear window	standard	standard
Door locks - with remote	power - all doors, single key	power - all doors, single key
Doors & exits	double 40/60 side & 50/50 rear	double 40/60 side & 50/50 rear
Engine - standard	6.0 L SFI gas V8	6.0 L SFI gas V8
Fuel capacity	117 L/31 US gal.	117 L/31 US gal.
Ground effects package	optional	optional
Mirror - interior	compass & exterior temperature	compass & exterior temperature
Mirrors - exterior	power - 7 1/2" x 8"	power - 7 1/2" x 8"
Power - standard	223 kW/300 HP	223 kW/300 HP
Receiver - class IV frame mounted	standard	standard
Running boards	aerodynamic with storage	aerodynamic with storage
Rust protection	optional	optional
Seats - Captains	swiveling, reclining, power lumbar supports & dual armrests	swiveling, reclining, power lumbar supports & dual armrests
Seats - leather	optional - Captain's & lounge seats	optional - Captain's & lounge seats
Sound system	premium AM/FM & CD	premium AM/FM & CD
Tire storage - spare	rear storage area or optional Continental kit	rear storage area or optional Continental kit
Tires	LT245/75R16E black wall	LT245/75R16E black wall
Torque - standard engine	490 N-m/360 ft. lbs.	490 N-m/360 ft. lbs.
Towing - GCWR * - standard	6350 Kg/14000 lbs. *	6350 Kg/14000 lbs. *
Towing - GCWR * - optional	not applicable	7258 Kg/16000 lbs. *
Towing - tow weight ** - standard	3000 Kg/6600 lbs. **	2750 Kg/6100 lbs. **
Towing - tow weight ** - optional	not applicable	3700 Kg/8100 lbs. **
Towing - tongue weight ***	454 Kg/1000 lbs. ***	454 Kg/1000 lbs. ***
Wheel liners (covers) - chrome look	optional	optional
Wheels - standard - steel	16" - with trim	16" - with trim
Wheels - optional - aluminum	16" - with steel spare	16" - with steel spare
Wheels - optional - polished chrome	16" - with steel spare	16" - with steel spare
Window operation	power - front doors only	power - front doors only
Window tint	deep tinted - all	deep tinted - all
Wiring harness for towing - 4 way	standard	standard
Wiring harness for towing - 7 way	optional (in addition to 4 way)	optional (in addition to 4 way)

\* Gross Combination Weight Rating (GCWR) includes total weight of vehicle, equipment, fuel, water, propane, cargo, driver and passengers.

\*\* Maximum towable weight with driver only. This weight reduced by weight of optional equipment, fuel, water, propane, cargo and/or passengers.

\*\*\* A weight distributing hitch is required for tongue weights over 200 Kg/400 lbs.

<b>2005 Standard Motorhome Features</b>	<b>Roadtrek 170 models on Chevrolet 2500 Regular Van</b>	<b>Roadtrek 190 models on Chevrolet 3500 Extended Van</b>
Air conditioner	110V recessed, 12000 BTU	110V recessed, 12000 BTU
Aisle	30"/760 mm wide	30"/760 mm wide
Battery - auxiliary - 12V	lead acid deep cycle, 95 amp-hrs.	lead acid deep cycle, 95 amp-hrs.
Battery storage - auxiliary	slide-out tray below floor	slide-out tray below floor
Beds - dual density foam	130 mm/5"	130 mm/5"
Cabinet - audio/video & storage	standard	standard
Carpet	40 oz. 100% Dupont nylon	40 oz. 100% Dupont nylon
Connection - auxiliary	Propane for BBQ w/quick disconnect	Propane for BBQ w/quick disconnect
Connection - external - 110V	standard	standard
Connection - external - TV cable	standard	standard
Connection - external - water	standard with quick disconnect	standard with quick disconnect
Counter top	molded fiberglass w/solid surface	molded fiberglass w/solid surface
Cupboard - galley slide-out	not available	not available
Detectors	smoke, propane & CO	smoke, propane & CO
Faucet - galley	single lever	single lever
Floor - lowered	1620 mm x 890 mm x 50 mm 64" x 35" x 2", no step over frame	1730 mm x 890 mm x 50 mm 68" x 35" x 2", no step over frame
Furnace - 'Suburban'	Propane automatic, 16000 BTU	Propane automatic, 16000 BTU
Generator ready package	for 'Onan'	for 'Onan'
Heat pump (A/C & heater)	'Dometic' with ducts to rear bed	'Dometic' with ducts to rear bed
Microwave oven - 110V	20 L/0.7 cu.ft., 700 W	20 L/0.7 cu.ft., 700 W
Monitor panel	water & propane levels, battery charge & battery disconnect	water & propane levels, battery charge & battery disconnect
Power inverter with charger	12/110V, 600W, w/3 step 45 amp charger.	12/110V, 600W, w/3 step 45 amp charger
Privacy area	with bi-fold doors, patented	with bi-fold doors, patented
Range hood - 12V	with exhaust fan & light	with exhaust fan & light
Refrigerator - 'Dometic'	12V/110V/propane, 3.0 cu.ft.	12V/110V/propane, 3.0 cu.ft.
Refrigerator venting	patented integrated	patented integrated
Roof vent - 'FanTastic' - 12V	low profile power w/thermostat	low profile power w/thermostat
Sewage disposal system	built-in sewage hose	built-in sewage hose
Shower	stand-up in aisle	stand-up in aisle
Sink	molded in counter w/flush cover	molded in counter w/flush cover
Storage area	across the rear	across the rear
Storage capacity - standard	49 cu.ft., 62 w/options	62 cu.ft., 80 w/options
Storage compartments - exterior	1 below floor	2 below floor
Stove - two burner	Propane recessed w/flush cover	Propane recessed w/flush cover
Table - dining - cloverleaf	32" x 32" open, 20" x 20" closed	32" x 32" open, 20" x 20" closed
Tank - Propane	38 L/10 US gal./45 lbs.	38 L/10 US gal./45 lbs.
Toilet - 'Thetford'	marine with foot pedal flush	marine with foot pedal flush
TV antenna - 'Hide-A-Tenna'	built-in	built-in
Water fill - fresh - location	front door post to reduce clutter & prevent tampering w/supply	front & rear door posts to reduce clutter & prevent tampering w/supply
Water heater - 'Suburban'	110V/propane with bypass, 23L/6 US gal., 12000 BTU	110V/propane with bypass, 23L/6 US gal., 12000 BTU
Water system - on demand	12V with 'Shurflo' water pump	12V with 'Shurflo' water pump
Water tank capacities	(see Interior Dimensions)	(see Interior Dimensions)
Windows	frameless awning type	frameless awning type
Windows - roof	3 frameless with curtains	3 frameless with curtains

2005 Exterior Dimensions	170 Models	190 Models
Length	5720 mm/18' 9" *	6220 mm/20' 5" *
Height - overall	2540 mm/8' 4"	2540 mm/8' 4"
Width - overall (w/o mirrors)	2010 mm/6' 7"	2010 mm/6' 7"
Wheel base	3430 mm/135"	3940 mm/155"
Unloaded vehicle weight ** (no opt.)	3250 Kg/7200 lbs.	3500 Kg/7700 lbs.
Gross vehicle weight rating	3900 Kg/8600 lbs.	4355 Kg/9600 lbs.

\* Add 250 mm/10" if equipped with optional Continental spare tire kit.

\*\* Includes weight of base vehicle and fuel only. Does not include weight of optional equipment, water, propane, cargo and/or passengers.

2005 Interior Dimensions	170 Models	190 Models
Standing height	1855 mm/73"	1855 mm/73"
King bed length	not applicable	1930 mm/76" left, 1830 mm/72" right
King bed width	not applicable	1855 mm/73"
Queen bed length	not applicable	not applicable
Queen bed width	not applicable	not applicable
Double bed length	1880 mm/74"	1880 mm/74"
Double bed width	1260 mm/50"	1320 mm/52"
Twin bed length - rear	not applicable	1930 mm/76" left, 1830 mm/72" right
Twin bed width - rear	not applicable	690 mm/27"
Single bed length - front	1660 mm/65"	1540 mm/61" left, 1660 mm/65" right
Single bed width - front	560 mm/22" (maximum)	560 mm/22" (maximum)
Water tank - fresh	55 L/14 US gal.	Interior 10 US gal./Exterior 15 US gal.
Water tank - grey	85 L/23 US gal.	85 L/23 US gal.
Water tank - black	30 L/ 8 US gal.	40 L/10 US gal.

2005 Motorhome Options	170 Models	190 Models
Armoire - with removable & adjustable shelves & drawers	optional, replaces right lounge seat	optional, replaces right lounge seat
Awning - box	optional, 3000 mm/9'8"	optional, 3500 mm/11'6"
Battery - second auxiliary	not available	optional, lead acid deep cycle, 12V, 190 total amp-hrs.
Coffee maker	not available	not available
DVD player	optional, with remote	optional, with remote
'Florida' room	optional, 3 screened sides & door with privacy panels & skirting	optional, 3 screened sides & door with privacy panels & skirting
Generator - 'Onan MicroLite'	optional, remote-start, 2.8 kW	optional, remote-start, 2.8 kW
Satellite receiver	not available	optional, w/auto search & lock
Screen package	optional for side van door windows and side & rear door openings	optional for side van door windows and side & rear door openings
Seat belts for 2 in rear	standard	standard on 190-Versatile, optional on 190-Popular
Table - dining - extendable	not available	optional, behind driver, replaces cloverleaf, 36"/51" x 19"/32"
TV - flat screen	optional, 15"	optional, 15"
Video cassette recorder	optional	optional
Wardrobe - removable	not available	optional, interchangeable with left lounge seat



<b>Introduction</b>	A-0
Gross Combination Weight Rating (GCWR)	A-1
<b>Daily Living</b>	B-0
Captain's Seats	B-1
Seat Belt Usage	B-1
Cloverleaf Dining Table	B-2
Dinette Table (Popular Models)	B-3
<b>Sleeping Facilities</b>	B-4
Rear Twin Beds (190-Popular Model)	B-4
Rear King-size Bed (190-Popular Model)	B-4 - B-5
Rear L-Shaped Lounge to Double Bed (190-Versatile & 170-Popular Models)	B-5
Rear Dinette to Double Bed (190-Versatile Model)	B-6
Dinette Table Storage	B-6
Front Lounge Seats	B-7
<b>Washroom and Privacy Area</b>	B-8
Rear Privacy Doors (190-Popular Model)	B-8
Rear Privacy Doors (190-Versatile Model)	B-9
Front Privacy Doors (Popular Models)	B-9
Front Privacy Doors (190-Versatile Model)	B-9
<b>Washroom Facilities</b>	B-10
Toilet	B-10
Stand-up Aisle Shower	B-10
Extra Counter Space	B-11
TV	B-11
<b>Exterior Access Doors</b>	B-12
Driver Side Access Doors (190 Models)	B-12
Driver Side Access Doors (170 Model)	B-13
Propane Access Door	B-14
Passenger Side Access Doors	B-14
Moto-Sat Satellite Antenna System (Optional)	B-15
Auxiliary Battery	B-16
Replacing the Auxiliary Battery	B-16
Spare Tire Storage	B-17
Continental Spare Tire Kit	B-17
Caution Note (Opening front side cargo door)	B-18
<b>Floor Plan &amp; Appliance Location</b>	C-0
Elevation (170-Popular Chevrolet)	C-1
Floor Plan with Appliance Location (170-Popular Chevrolet)	C-2
Elevation (190-Popular Chevrolet)	C-3
Floor Plan with Appliance Location (190-Popular Chevrolet)	C-4
Elevation (190-Versatile Chevrolet)	C-5
Floor Plan with Appliance Location (190-Versatile Chevrolet)	C-6
Electrical System Legend	C-7
<b>Appliance Log</b>	D-0
170 and 190 Chevrolet Roadtrek Appliance & Accessory Manufacturer's Log	D-1

<b>Electrical System</b>	E-0
<b>Electrical System</b>	E-1
Inverter	E-1
10V Inverter/Charger Shut Down	E-1
Inverter/Charger Start up After Automatic Safety Shut Down	E-1
Dry Camping Battery Conservation	E-1
Receptacle Functionality	E-1
120 / 12V Inverter / Charger / Distribution Panel	E-2
External Electrical Source Connection	E-2
Generator	E-2
Built-in 110 V Heat Pump - Air Conditioner	E-2
TV	E-3
Monitor Panel	E-3
Auxiliary Battery and Isolator	E-4
Automotive Battery	E-4
Interior Cab Light	E-4
Range Hood Exhaust Fan	E-4
Water Heater	E-4
Electrical System Schematics	E-5 - E-6 - E-7 - E-8
<b>Propane &amp; Safety System</b>	F-1
Propane Tank	F-2
Appliances	F-2
Refueling Procedures	F-2
Regulator	F-2
Propane Leak Detector	F-3
Carbon Monoxide Leak Detector	F-3
Smoke Detector	F-3
Propane System Schematic (170-Popular Chevrolet)	F-4
Propane System Schematic (190-Popular Chevrolet)	F-5
Propane System Schematic (190-Versatile Chevrolet)	F-6
<b>Water Systems</b>	G-0
Filling the Interior Fresh Water Tank (190 Models only)	G-1
Filling the Exterior Fresh Water Tank (All Models)	G-1
City Water Connection	G-2
Waste Water Storage and Dumping System	G-3
Waste Water Tank Preparation	G-3
Waste Water Tank Dumping	G-4
Waste Water Tank Flushing	G-5
Outside Shower	G-5
Potable Water System Draining	G-5
Potable Water System Sanitizing	G-6
Potable Water System Winterizing	G-6
Winter Mode Valve Positions (190 Models only)	G-7
Summer Mode Valve Positions	G-7
Winter Use (Moderate Subfreezing Conditions) (190 Models only)	G-7
To De-Winterize	G-9
Water Systems Schematic (190 Chevrolet)	G-10
Water Systems Schematic (170-Popular Chevrolet)	G-11

Water Systems Schematic (170-Popular Chevrolet)	G-12
Water Systems Schematic (190-Popular Chevrolet)	G-13
Water Systems Schematic (190-Versatile Chevrolet)	G-14
<b>Owner Maintenance</b>	H-0
Exterior Maintenance	H-1
Exterior Washing	H-1
Other Maintenance	H-1
Winter Storage	H-1
Inside Your Vehicle	H-1
Outside Your Vehicle	H-1
Spring Start-Up	H-2
Tires	H-2
Cargo Carrying Capacity	H-2
Owner Maintenance Checks	H-2
When You Stop for Fuel	H-2
At Least Monthly	H-2
At Least Once Every Three Months	H-2
At Least Twice A Year	H-3
At Least Once A Year	H-3
Auxiliary Battery	H-3
Aluminum Wheel Maintenance	H-4
<b>Limited Warranty Information</b>	I-0
Limited Warranty Definitions	I-1
Home & Park Limited Warranty Registration Card	I-1
Automotive Warranty - General Motors (Chevrolet Chassis)	I-1 - I-2
Limited Warranty Information	I-2
Automotive Customer Service & Roadside Assistance Numbers	I-2
Appliance Warranty	I-2
Manufacturer Contact Information	I-3
Home & Park Limited Motorhome Warranty	I-4 - I-5
<b>Customer Assistance</b>	J-0
Reporting Safety Defects (U.S. Only)	J-1
Roadtrek Ambassador Potential Customer Referral Program for Roadtrek Owners	J-1
Roadtrek Club International	J-2
Address, Phone & Facsimile Numbers, and E-mail	J-2
Website	J-2
<b>Obtaining Motorhome Service</b>	K-1
<b>Roadtrek International Chapter FMCA / A Roadtrek Owners' Club Membership Forms</b>	L-1
<b>Change of Owner Name or Address Form</b>	L-2
<b>Potential Customer Referral Card</b>	L-4

## A WORD TO ROADTREK OWNERS...

---

This manual has been prepared to acquaint you with the operation, maintenance and warranties of your new **Roadtrek Motorhome Van**. Your vehicle has been designed, engineered and manufactured to provide you with the utmost in pleasure, dependability and quality. It is important that you read the contents of this manual, that of the Chevrolet chassis and those of other components, and follow the instructions and recommendations contained in each to help assure the most enjoyable and trouble free operation of your vehicle.

We would like to take this opportunity to thank you for selecting a **Home & Park** product and assure you of our continuing commitment to your recreational vehicle pleasure, safety and satisfaction.

## INTRODUCTION

---

This manual has been written to provide you with the information required to properly operate and maintain your new Roadtrek. After reading this manual, be sure to keep it in your vehicle as a reference. Your Home & Park dealer will be glad to answer any further questions about the operation of your vehicle.

## IMPORTANT

---

Every reasonable precaution has been undertaken in the preparation of this manual resulting in the utmost accuracy possible at the time of publication. However, due to the continuing improvement and refinement of our products and normal changes in information and procedures, Home & Park shall assume no responsibility whatsoever for errors or omissions in the manual's contents.

Further, Home & Park shall not be held liable or assume any obligations or responsibilities whatsoever for any loss, damage or injury directly or indirectly caused by, arising or resulting from, or as a consequence of the use or nonuse of the information contained herein or the operation or non-operation of any items mentioned herein. And finally, Home & Park shall be indemnified and saved harmless from all losses, expenses, claims and demands whatsoever.

### Gross Combination Weight Rating (GCWR)

The Chevrolet 3500 extended van has a GCWR of 6350 Kg/14000 lbs for the standard engine (6.0 L) and 7258 Kg/16000 lbs for the optional 4.10 rear axle ratio.

**Gross Vehicle Weight Rating (GVWR):** is the maximum permissible weight of this vehicle when fully loaded. It includes all weight at the vehicle axle(s).

**Unloaded Vehicle Weight (UVW):** is the weight of this motorhome as manufactured at the factory. It includes all weight at the vehicle axle(s). If applicable, it also includes full generator fluids, including fuel, engine oil and coolants.

**Cargo Carrying Capacity (CCC):** is equal to GVWR minus each of the following: UVW, full fresh (potable) water weight (including water heater), and full propane weight and SCWR.

**Gross Combination Weight Rating (GCWR):** (motorhomes only): means the maximum allowable loaded weight of this motorhome and any towed trailer or towed vehicle.

**Sleeping Capacity Weight Rating (SCWR):** (motorhomes only): is the manufacturer's designated number of sleeping positions multiplied by 154 pounds (70 kilograms).

**Gross Axle Weight Rating (GAWR):** is the value specified as the load carrying capacity of a single axle system, as measured at the tire-ground interfaces.

**Towing Guidelines:** Consult Chevrolet Owners Manual(s) for specific weighing instructions and towing guidelines including auxiliary brake requirements for any towed trailer or towed vehicle.

**Weighing Procedure:** Prior to weighing each unit, the fuel tank must be full, as well as the fresh water tank. All tires must be of equal pressure, and any snow must be removed.

**Note the weighing must be done on level ground!**

**Equipment:** 2 Portable Scales (including electrical power source), 2 wooden ramps, lift and pressure gauge.

**Alternate:** D.O.T. approved customer scales

**Note:** Wooden ramps must be equal to or less than 1/8" of the height of the scales being used.

**Procedure:**

- 1) Fill Fuel Tank
- 2) Fill Fresh Water Tank
- 3) Measure all tire pressures and equalize if necessary
- 4) Place wooden ramps below rear wheels (using lift or driving onto ramps for levelling vehicle; N/A if commercial scales used)
- 5) Place scales under front wheels
- 6) Record scale readings
- 7) Repeat for rear wheels
- 8) Fill Propane Tank

VIN: 1GBHG31U1 31205833 MANUFACTURED BY: HOME & PARK MOTORHOMES

**MOTORHOME WEIGHT INFORMATION**

GCWR (GROSS COMBINED WT RATING): THE MAX. ALLOWABLE LOADED WT OF THIS MOTORHOME & ANY TOWED TRAILER OR TOWED VEHICLE 9600 4,354

UVW (UNLOADED VEHICLE WT): THE WT OF MOTORHOME AS MANUFACTURED AT THE FACTORY WITH FULL FUEL, ENGINE OIL & COOLANTS 7570 3,434

SCWR (SLEEPING CAPACITY WT RATING): THE MANUFACTURER'S DESIGNATED NO. OF SLEEPING POSITIONS X 154 POUNDS (70 KILOGRAMS) 462 210

CCC (CARGO CARRYING CAPACITY): = GVWR - (UVW + FULL FRESH/POTABLE WATER W/INCLUDING HOT WATER) + FULL LP-GAS WT + SCWR 271 123

WEIGHING: CONSULT OWNER MANUAL(S) FOR SPECIFIC GVWR 9600 4,354

WEIGHING INSTRUCTIONS & TOWING GUIDELINES MINUS UVW 7570 3,434

MINUS FRESH & HW WT (32 + 6) GALLONS @ 8.3 lb/gal 317 144

MINUS LP-GAS WT OF 9.8 GALLONS @ 4.5 lb/gal 42 19

MINUS SCWR OF 3 PERSONS @ 154 lb/person 462 210

MINUS TOTAL FACTORY SUPPLIED OPTION WT 271 123

DEALER INSTALLED EQUIPMENT AND TOWED VEHICLE MINUS TOTAL FACTORY SUPPLIED OPTION WT 938 426

TONGUE WEIGHT WILL REDUCE CCC

	GAWR	TIRES	RIMS	COLD INFL. PRESS.	SINGLE	DUAL
FRONT	4100 lb ( 1860 kg)	LT245/75R16-E	16 x 6.5J	50 PSI ( 340 kPa)	X	
REAR	6084 lb ( 2760 kg)	LT245/75R16-E	16 x 6.5J	80 PSI ( 550 kPa)	X	

TYPE OF VEHICLE: MPV CLASS B MOTORHOME SO 63145 Manufactured 16-Oct-03

THIS VEHICLE CONFORMS TO ALL APPLICABLE U.S. FEDERAL MOTOR VEHICLE SAFETY STANDARDS IN EFFECT AS OF: 16-Oct-03

Paint Identification: Chassis Paint Code: 50UWAU8624 Deluxe Paint Code: MM203.50

Sample of US Weight label:

MANUFACTURED BY / FABRIQUE PAR: HOME & PARK MOTORHOMES Date: 23 Jul 03

INCOMPLETE VEHICLE MANUFACTURED BY/VEHICULE INCOMPLÉTEMENT CONSTRUIT PAR: GENERAL MOTORS CORPORATION Date: 01-Jan-03

GVWR/PNBV: 4355 Kg VIN/NIV: 1GBHG31U2 31183155

SEATING CAPACITY / NOMBRE DÉSIGNÉ DE PLACES ASSISSES: ( 3 x 70 ) = 210 Kg

GAWR/PMBE (KG)	TIRE/PNEU	RIM/JANTE	COLD INFL. PRESS. / PRESS. DE GONFL. À FROID
			PSI/KPa
FRONT 1860	LT245/75R16-E	16 x 6.5J	50 340
REAR 2760	LT245/75R16-E	16 x 6.5J	80 550

CARGO CAPACITY 500 (kg) CAPACITÉ DE CHARGEMENT 500 (kg)

CALCULATED WITH FRESH WATER TANKS FULL: CALCULÉE AVEC LES RÉSERVOIRS D'EAU DOUCE PLEINS: SO

(COLD) 121 (kg) (FROID) 121 (kg) 6

(HOT) 23 (kg) (CHAUD) 23 (kg) 2

AND THE WASTE WATER TANKS EMPTY ET LES RÉSERVOIRS D'EAUX USÉES VIDES 0

WASTE WATER TANKS CAPACITY 182 (kg) CAP. DES RÉSERVOIRS D'EAUX USÉES 182 (kg) 0

Paint Identification: Chassis Paint Code: 50UWAU8624 Deluxe Paint Code: B.M.W.442

Sample of Canadian Weight label:



**CAPTAIN'S SEATS:**

To recline, pull up the recline control lever below the inboard armrest and lean back.

To slide, pull up on the slide bar located on the front of the seat and slide the seat either forward or back, (see Picture B-P1B).

To swivel the seats from a forward facing position to a rearward facing position pull the swivel lever up, (see Picture B-P1A).

**Important Note:** Before swiveling the seat you must be aware of the following:

1. Ensure that the back of the seat is reclined forward, as far as the recline control allows.
2. Slide the seat forward but not so far as to lose clearance of the engine cover. Pull up on slide bar, (see Picture B-P1B).
3. Put the tilt steering wheel in the downward position.
4. The swivel lever is located on the door side of the seat and locks the seat in a forward facing position. To release pull the swivel lever up and the seat freely swivels, (see Picture B-P1A).
5. Swivel the seat to the desired position, (see Picture B-P2).

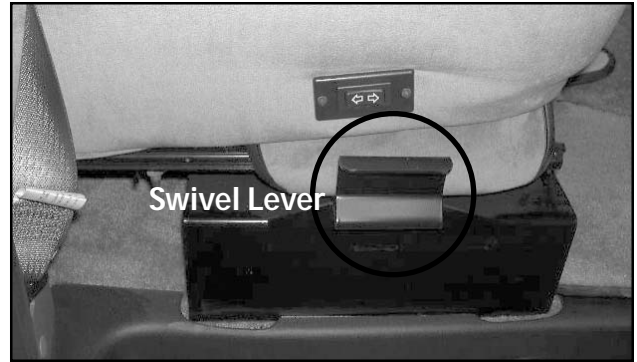

Picture B-P1A: View of the side of the Captain's seat, showing the location of the swivel lever.

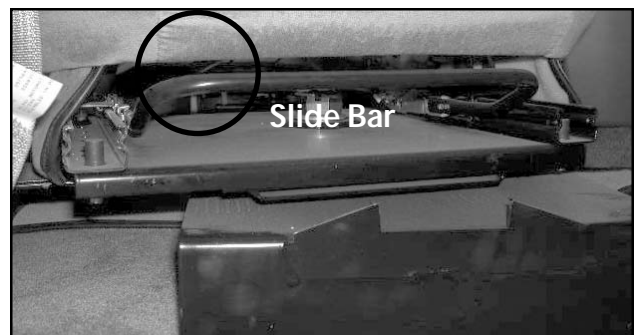

Picture B-P1B: View of the front of the Captain's seat, showing the location of the slide bar.



Picture B-P2: Captain seats swiveled towards the rear of the Motorhome.

**SEAT BELT USAGE:**

Only forward facing seats equipped with factory installed seat belts are to be occupied while the vehicle is in motion. All passengers must be seated in these seats only with the seat belts fastened while the vehicle is in motion.

**CLOVERLEAF DINING TABLE:**

The cloverleaf dining table is stored in the front wardrobe closet, (see Picture B-P3 for Popular models and see Picture B-P4 for Versatile models). Remove table leg and place it in the floor base receptacle located in front of the wardrobe. Place table top on top of table leg.

To use the "leaves":

1. Pivot the table into the desired position.
2. In a seated position, with one hand on the top of the table, use the other hand to unfold the desired leaf to the upright position.

To return the "leaf" to its original position, follow these steps:

1. Hold the leaf with one hand.
2. With the other hand reach under the table and carefully press on the center of the downward facing part of the spring hinge.
3. Fold the leaf back into the stored position.

**Caution:** Cloverleaf dining table is heavy, lift bending knees.



Picture B-P3: Wardrobe closet showing location of the table and table support pole, (Popular models).



Picture B-P4: Storage location of cloverleaf table, (Versatile models).



**DINETTE TABLE:**

The table leg is stored in the front wardrobe closet, (see Picture B-P3). Remove the table leg and place in the floor base receptacle located at the rear next to the night table.

The table top is stored under the driver side rear bed cushion, (see Picture B-P6 and B-P8). Place table top on table leg, (see Picture B-P5 and B-P7).

When returning table top to the storage position ensure the table base is placed correctly in the table base receptacle located on top of the rear driver side bench, (see Picture B-P6 and B-P8). Return table leg to front wardrobe closet and clip into place for proper storage, (see Picture B-P3 for Popular models and see Picture B-P2 for Versatile models).



**Picture B-P5:** Location of assembled dinette table, (Popular models).



**Picture B-P6:** Storage location of dinette table, showing placement of the table base receptacle, (Popular models).



**Picture B-P7:** Location of assembled dinette table, (Versatile models).



**Picture B-P8:** Storage location of dinette table, showing placement of the table base receptacle, (Versatile models).

**SLEEPING FACILITIES:**

**REAR TWIN BEDS (190-Popular Model):**

To convert the dinette into twin beds:

1. Remove the table and leg from its receptacle and place the table under the driver side seat cushion, (see Picture B-P6 on page B-3).
2. Place both back rest cushions on the floor vertically up against the seat base boxes or store if desired.

**Warning:** Do not allow cushions to block furnace vents.

3. Pull each seat cushion 3" (8 cm) from the wall to provide additional elbow room while sleeping.
4. Night table can be removed and stored if desired, (see Picture B-P9).

To convert back to a dinette, perform these steps in reverse order.

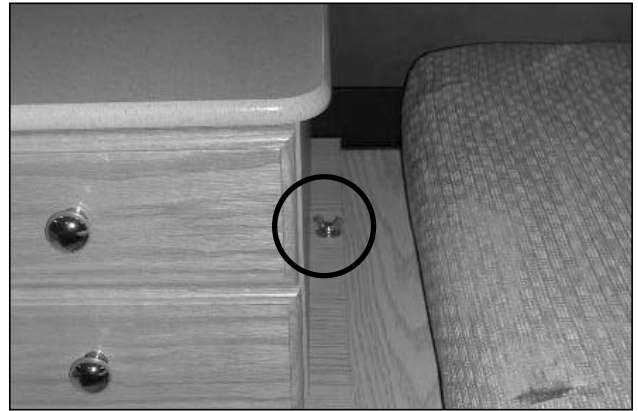

Picture B-P9: Wing nuts attaching the night table, are accessed from the sides of the night table as pictured above, (Popular model).

**REAR KING-SIZE BED (190-Popular Model):**

To convert the dinette into a king-size bed:

1. Remove the privacy curtain from its Velcro support on the lower edge of the suspended cupboard door.
2. Remove the table and leg from its receptacle.
3. Remove night table and store. In order to remove, unscrew the wing bolt found on each side of the night table, (see Picture B-P9). Store wing nut in the night tables drawer when not in use.
4. Place table top in center and wood insert as shown, (see Picture B-P10).
5. Place both bolster cushions, (back rests) in centre in a tepee position, (see Picture B-P11).

NOTE: The longer bolster cushion must be placed on the driver side, so as to provide clearance for the bathroom door.

6. Push down the bolster cushions so they lay flat to create the king size bed.

To convert back to a dinette, perform these steps in reverse order.

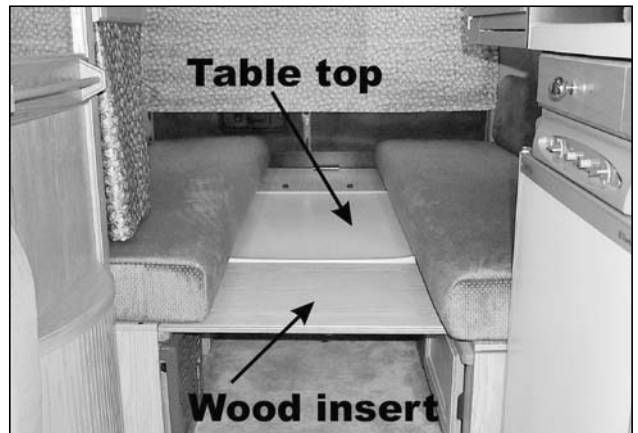

Picture B-P10: Placement of support pieces for the king size bed, (Popular model).



Picture B-P11: Placement of back rest cushions, (Popular model).

## REAR KING BED

If desired, place the small cushion insert at the rear of the bed to create additional bed length, (see Picture B-P12 and Picture B-P14).

## REAR L-SHAPED LOUNGE TO DOUBLE BED (190-Versatile & 170-Popular Models):

1. Remove the table and leg from their base and place the table on the lateral support located on the upper edge to seat base boxes, (see Picture B-P13).
2. Remove center dinette cushion, (see Picture B-P15). Center dinette cushion is extra.
3. Unfold back rest cushions and place on top of table, (see Picture B-P16).

Note: The shorter passenger side seat rest cushion goes on the bottom, rear back rest cushion on top.



Picture B-P12: Small cushion insert - before insertion, (190 Popular model).



Picture B-P13: Placement of support pieces for the double bed, (Versatile model).

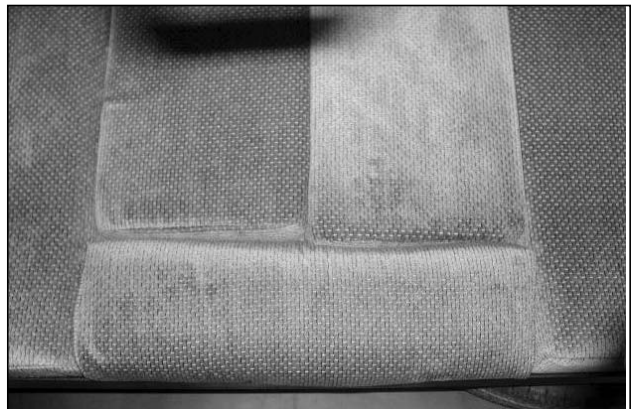

Picture B-P14: Small cushion insert in place creates more sleeping surface, (190 Popular model).

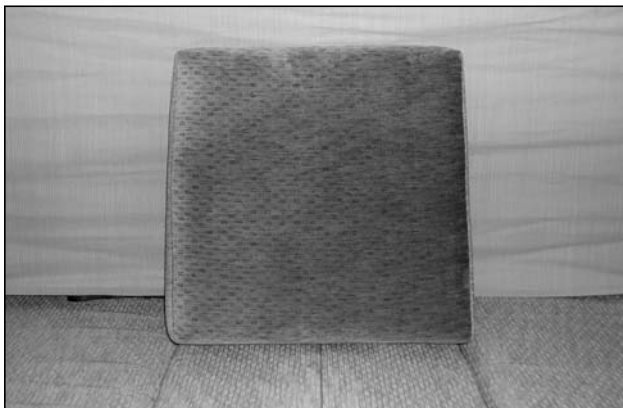

Picture B-P15: Centre dinette cushion, (Versatile model).



Picture B-P16: Placement of back rest cushions, (Versatile model).

**REAR DINETTE TO DOUBLE BED (190-Versatile Model):**

- To convert the dinette into a double bed.
1. Remove table leg and store, (see Picture B-P4).
  2. Place the table in centre, (see Picture B-P18).
  3. Place both back rests in the centre in a tepee position, (see Picture B-P19).
  4. Push down on the top of the cushion "tepee" until they lay flat, (see Picture B-P20).



Picture B-P17: Rear dinette living setup.



Picture B-P18: Placement of table top for bed.



Picture B-P19: Arrange cushions like a tepee



Picture B-P20: Lay cushions flat.

**DINETTE TABLE STORAGE**

Remove the table leg and store.

Note: The dinette table leg is stored behind the rear closet door, (see Picture B-P4 on page B-2).

1. The dining table is stored under the driver's side rear cushion, (see Picture B-P21).



Picture B-P21: Dining table storage.

**FRONT LOUNGE SEATS:**

To convert the lounge seat into a single bed:

1. Be sure all armrests are in an upright position. Swivel the passenger captain's seat 270 degrees counter clockwise so that the backrest is toward the center aisle, (see Picture B-P22).
2. Slide out the drawer under the passenger seat and fully extend the drawer forward until it touches the raised platform, (see Picture B-P23). Raise the support block located at the front of the drawer, (see Picture B-P24).
3. Lift the back rest cushion upward, (on the lounge seat) remove it from its metal support and place it flat on top of the drawer, with the tapered end forward, (see Picture B-P25).



Picture B-P22: Swiveled front captain seat.



Picture B-P23: Extended drawer.

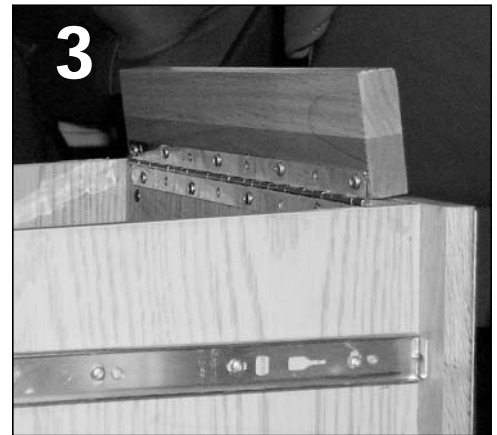

Picture B-P24: Raised support.



Picture B-P25: Front lounge bed.

To convert back to a lounge seat, perform these steps in reverse order.

The lounge seat is designed to carry a passenger while your vehicle is in motion and is equipped with seat belts installed for their protection. All passengers must be seated in the front captain's seats facing forward or the passenger lounge seat with seat belts fastened while vehicle is in motion. All other seats are not to be occupied while vehicle is in motion. The lap belts must be worn across the hips and not across the abdomen. Passengers must sit well back in the seat and in an upright position.

**WASHROOM AND PRIVACY AREA:**

**REAR PRIVACY DOORS (190-Popular Model):**

---

When privacy is required:

1. Open the door on the suspended cupboard on the passenger side of your vehicle, by pressing the side latch.
2. Release the plastic turn tab, (found near the top of the inside door) that secures the inner door, extend this door until privacy is achieved, (see Picture B-P26).
3. Ensure the privacy door is secured behind the A/V door, (see Picture B-P27).
4. If desired, hang the curtains from the Velcro located on the lower edges of these doors to maintain complete privacy.

To close the rear privacy doors perform these steps in a reverse order.



Picture B-P26: Rear privacy door in place, (190 Popular model).



Picture B-P27: Position of rear privacy door when secured behind A/V door, (190 Popular model).

### **REAR PRIVACY DOORS (190-Versatile Model):**

---

Open wardrobe door.

1. To open bi-fold door turn button 180 degrees and extend bi-fold door until privacy is reached, (see Picture B-P28).



Picture B-28: Opened bi-fold door, (Versatile model).

### **FRONT PRIVACY DOORS (Popular Models):**

---

When privacy is required:

1. To open the front privacy door, (toilet door) press the round latch located to the right of the towel bar until it pops out and pull on latch to open door.
2. Release the plastic turn tabs that secure the inner door and extend this door until privacy is achieved, (see Picture B-P29).
3. Complete privacy in this area can now be achieved by closing the curtain at the galley window.



Picture B-P29: Front privacy door opened, (190 Popular model).

### **FRONT PRIVACY DOORS (190-Versatile Model):**

---

1. Open bathroom door and turn button 180 degrees. Extend bi-fold door until privacy is obtained, (see Picture B-P30).

NOTE: Bi-fold will secure on microwave edge.

When the privacy doors are returned to a closed position, ensure one that the inner doors are secured with the plastic tabs and secondly that the doors themselves are closed properly to prevent the doors from opening while traveling.



Picture B-P30: Extended bi-fold door, (Versatile model).



**WASHROOM FACILITIES:**

**TOILET:**

1. Ensure that you achieve privacy by extending all privacy doors and closing the gallery curtain.
2. See appropriate component Manufacturer's Owner's Manuals for operating instructions.

**STAND-UP AISLE SHOWER:**

To set up the stand-up aisle shower:

1. Remove floor drain cover and drain plug from floor, (see Picture P-B31).
2. Ensure that you achieve privacy by extending all privacy doors and closing the gallery curtain.
3. Release the Velcro retention straps and move the hand held shower from its storage position on the shelf to its shower position, (see Picture B-P32).
4. Draw the shower curtain until you are completely surrounded.
5. Using the Velcro connectors, secure the edges of the curtain together allowing the shower hose to hang within the shower area to retain any dripping water inside the curtains.
6. When adjusting the water temperature, be sure to allow enough time for the temperature adjusted water to exit the shower head before making further adjustments.

**Note:** To conserve water, **discontinue the water flow at the shower head between wetting and rinsing.**

To put away the stand-up shower:

1. Rinse and dry the shower curtain thoroughly, (this function is most easily performed before leaving the shower area after use).
2. Allow the curtain to air dry completely, (this function can be expedited using the power roof vent).
3. Replace drain plug in floor when finished.

**To prevent grey water tank contents from spilling onto the floor while driving, keep the drain plug secured when not in use.**

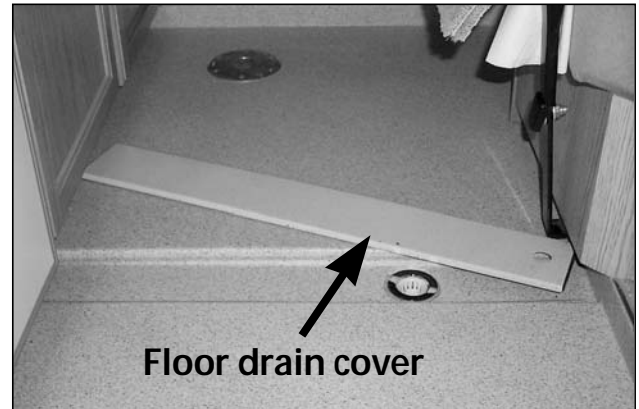

Picture B-P31: Floor drain, remove floor drain cover using the access holes provided in the cover.

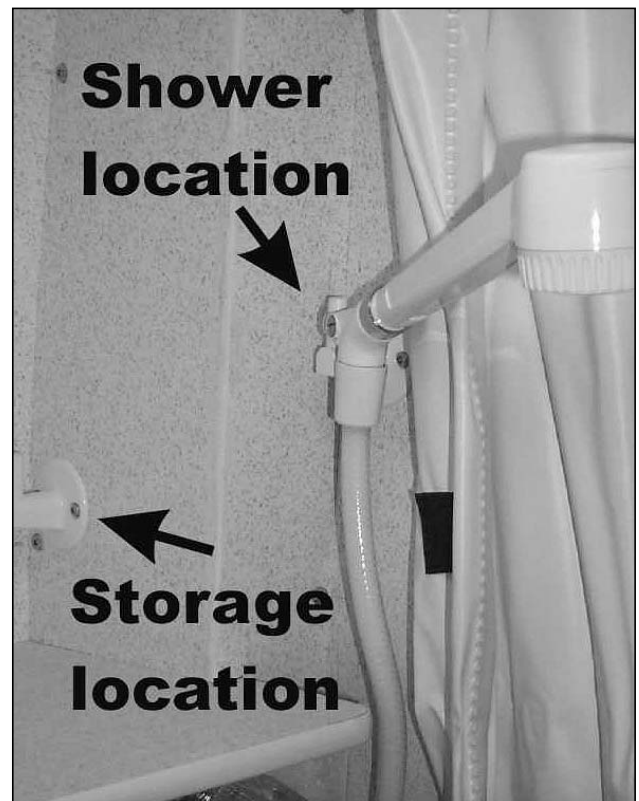

Picture B-P32: Hand held shower head in its shower position.



**EXTRA COUNTER SPACE:**

In order to provide additional counter space, your motorhome has the following three features:

1. stove counter top.
2. slide out shelf above the cutlery drawer.
3. slide out shelf below the TV.

To provide additional counter space the stove has a removable cover, to remove the cover do the following:

1. The stove cover is friction fit so you just need to lift and remove, (see Picture B-P33).
2. Store cover while cooking, when finished replace stove counter top.

**CAUTION:** Make sure the stove is off and has cooled prior to replacing stove counter top.

Additional counter space is provided above the cutlery drawer, to access do the following:

1. Open cutlery drawer.
2. Reach under and slide the shelf forward, (see Pictures B-P34 and B-P35). When shelf is no longer in use wipe down and close cutlery drawer.



Picture B-P33: Lifting stove counter top.



Picture B-P34: Counter top drawer partially open.



Picture B-P35: Counter top drawer fully open.

**TV:**

To view the flat screen display, loosen the thumb tab and swing the screen to the position you desire, (see Picture B-P36).

**CAUTION:** When vehicle is in motion it is recommended that the TV be "OFF" and in the stored position. The thumb tab should be secured once the TV is in the stored position.



Picture B-P36: Flat screen thumb tab.

**EXTERIOR ACCESS DOORS:**

**DRIVER SIDE ACCESS DOORS (190 Models):**

Behind the lockable front access door, (see Picture B-P38), the following are found:

1. Sewage carrier and hose.
2. Grey water gate valve handle.
3. Black water gate valve handle.
4. Exterior fresh water drain valve.

Behind the lockable middle access door, (see Picture B-P39), the following are found:

1. The power cord.
2. Storage for exterior shower hose.
3. Large storage area.

Behind the lockable rear access door, (see Picture B-P40), the following are found:

1. The city water connection, (integrated at the side behind the rear access door).
2. The city water by-pass valve.
3. The exterior shower taps.
4. The cable TV connection.

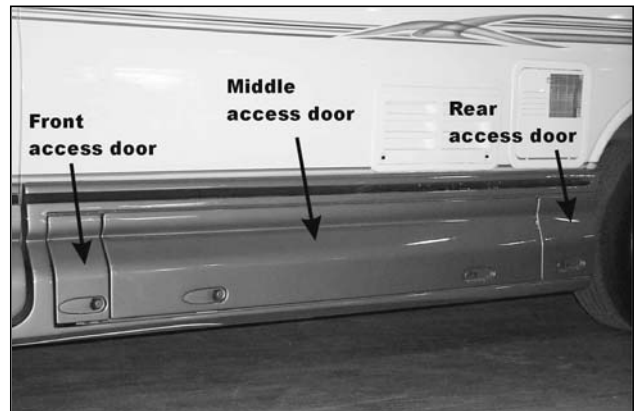

Picture B-P37: Driver side access doors, (190 models).



Picture B-P38: Front access door, (190 models).



Picture B-P39: Middle access door, (190 models).

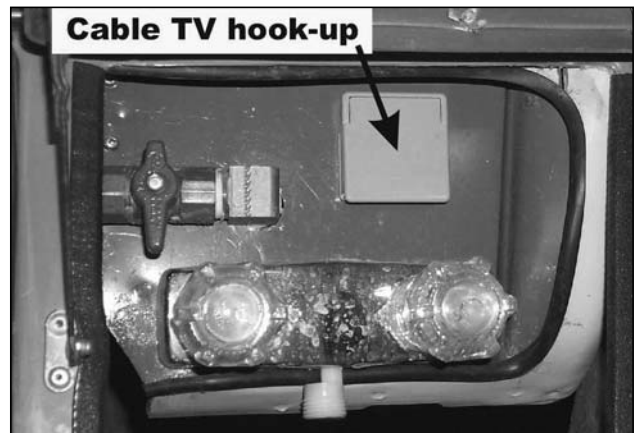

Picture B-P40: Rear access door.

**DRIVER SIDE ACCESS DOORS (170 Model):**

Behind the lockable front access door, (see Picture B-P42), the following are found:

1. Sewage carrier and hose.
2. Grey water gate valve handle.
3. Black water gate valve handle.
4. Fresh water drain valves, (see Picture B-P43).

Behind the lockable rear access door, (see Picture B-P44), the following are found:

1. The power cord.
2. Storage for exterior shower hose.
3. Large storage area.

Behind the lockable front access door, (see Picture B-P42), the following are found:

1. The city water connection, (integrated at the side behind the rear access door).
2. The city water by-pass valve.
3. The exterior shower taps.
4. The cable TV connection.



Picture B-P41: Driver side access doors, (170 model).

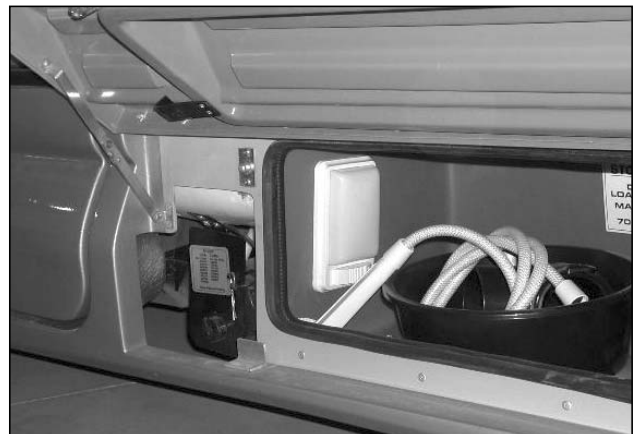

Picture B-P42: Front access door, (170 model).



Picture B-P43: Exterior fresh water drain valve, (170 model).



Picture B-P44: Rear access door, (170 model).

**PROPANE ACCESS DOOR:**

Behind the **propane access door**, (integrated into the rear bumper, covered with a black plate), (see Picture B-P45), the following are found:

1. Propane fill valve.
2. Propane tank shut off valve.
3. Portable barbecue connection.

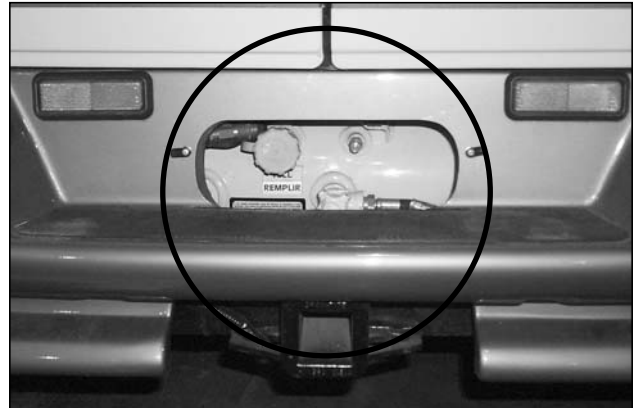

Picture B-P45: Propane access.

**PASSENGER SIDE ACCESS DOORS:**

Behind the **access door behind the rear wheel**, (see Picture B-P46), the following is found:

1. Slide out tray with auxiliary battery.

Behind the lockable **access door in front of the rear wheel**, (see Picture B-P47), the following is found:

1. Storage area or second auxiliary battery, (when installed), 190 models only.

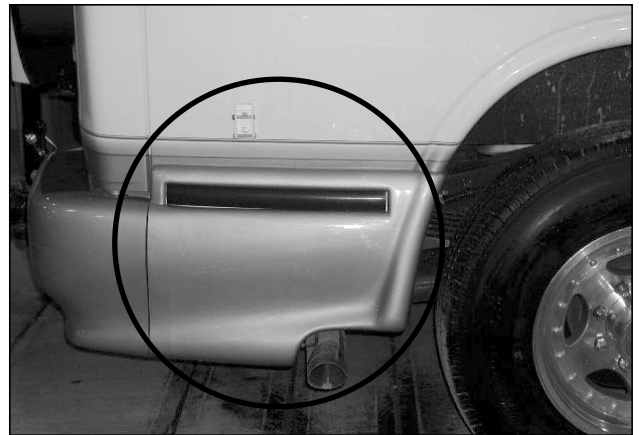

Picture B-P46: Access door behind rear wheel.

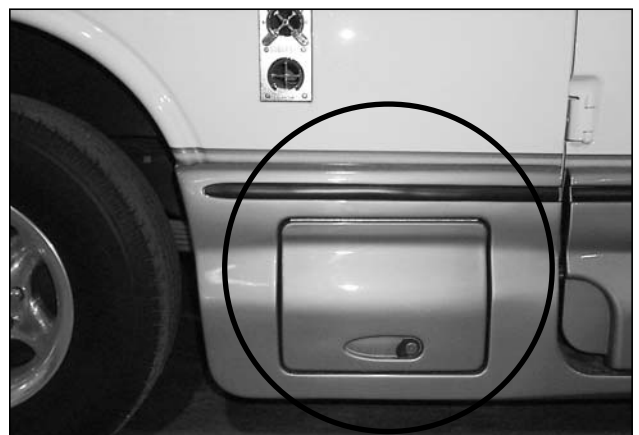

Picture B-P47: Dual battery access door in front of the rear wheel.

**MOTO-SAT SATELLITE ANTENNA SYSTEM (Optional):**

Satellite service is not provided. This must be arranged by the customer with service being offered by a choice of companies including DirecTV, Dish Network and Bell Express Vu.

The satellite signal strength can be compromised if the path to the satellite is obstructed by buildings and/or trees, which can cause poor or no reception. The satellite system must not be used while the vehicle is in motion.

The satellite provides instant TV reception in the most remote of locations, (see Picture B-P48). The satellite system is completely automatic, one selects "Find Satellite" and the dish will do the rest. There are on screen menus for ease of operation.

When in the stowed position, the dish is 9 1/2 inches high, (see Picture B-P49). The dish has auto stow within one (1) minute if the vehicle is moved.

Moto-Sat warrants equipment to be free from defects in material and workmanship under conditions of normal use for a period of two (2) years from date of purchase.

Moto-Sat Customer Service Department is available toll free at 800-247-7486.



Picture B-P48: Satellite in "up" or ready for use position.



Picture B-P49: Satellite in "stowed" or travel position.

**SIGNAL SELECTION SWITCH:**

Optional Satellite:

- A: Antenna.
- B: Satellite.
- C: Cable.

Standard:

- A: Antenna.
- B: Cable.

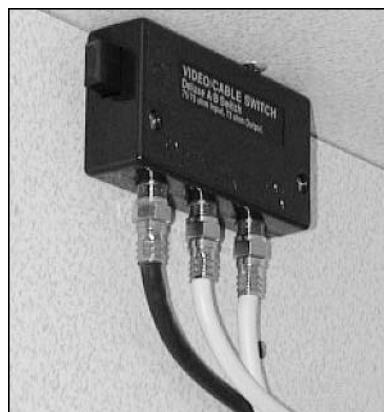

Picture B-P49: Signal selection switch, (standard).

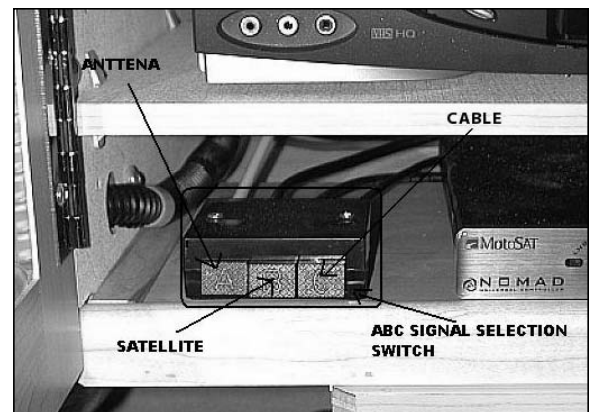

Picture B-P49A: Signal selection switch, (optional satellite).

**AUXILIARY BATTERY:**

The auxiliary battery is located behind the passenger access door behind the rear wheel, (see Picture B-P46). Under heavy use it is recommended to check once a month, see maintenance section.

In order to access the auxiliary battery one must do the following:

1. Unscrew wing bolt, (see Picture B-P50).
2. Pull down on release handle above the exhaust pipe, (see Picture B-P51).
3. Lift barrel bolt.
4. Slide out battery tray.

**CAUTION: DO NOT ATTEMPT TO REMOVE BATTERY COVER WHILE ENGINE IS RUNNING / EXHAUST IS HOT. HOT EXHAUST CAN BURN.**

To reinstall reverse steps above.

**CAUTION: BATTERY ACID CAN BURN SKIN AND CLOTHING. PROTECTIVE EYE WEAR AND GLOVES SHOULD BE WORN WHEN HANDLING.**

Observe all battery warnings and caution labels.

**NOTE:** Your vehicle is equipped with a group 27 lead acid auxiliary battery. It is recommended that acid levels be checked at least once every 3 months. See battery manufacturers maintenance recommendations.

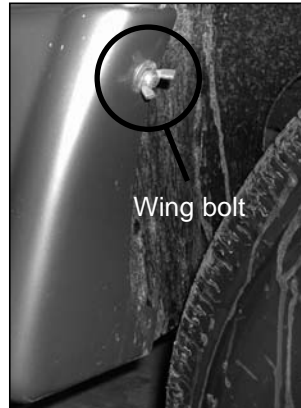

Picture B-P50: Wing bolt.

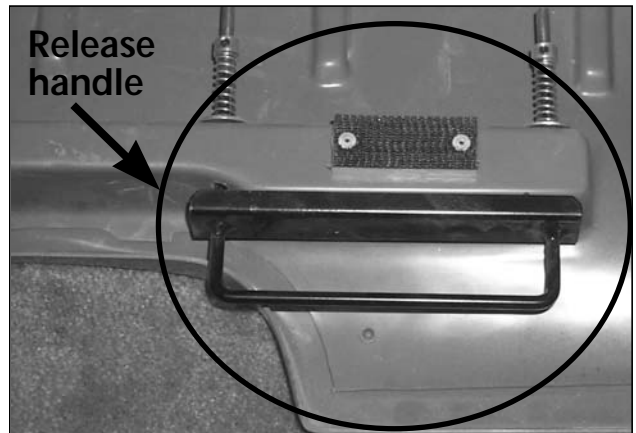

Picture B-P51: Location of battery cover release handle.

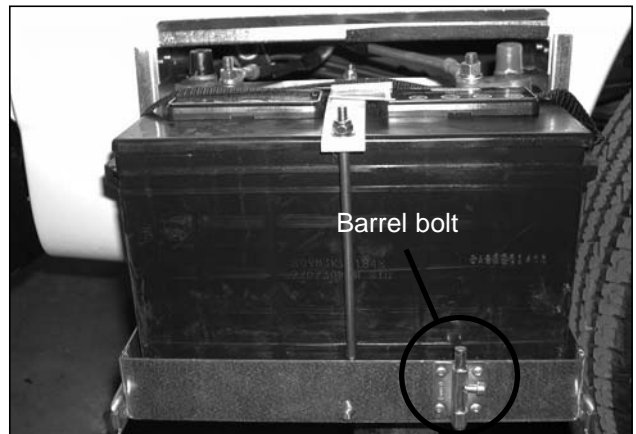

Picture B-P52: Auxiliary Battery.

**REPLACING THE AUXILIARY BATTERY:**

Ensure that you maintain a minimum of a 3/8 inch clearance between the battery posts and the top edge of the compartment. Replacement battery is a group 27 deep cycle lead acid or equivalent.

Ensure that the battery cable hex nuts are tightened to 10 ft-lbs, (see Picture B-P52).

## SPARE TIRE STORAGE:

The spare tire is located in the storage area found under the passenger side rear bed.

Brace yourself for the weight of the tire, (40 kg / 80 lbs).

The jack is located in the storage area found under the passenger side rear bed mounted on the outside wall, (see Picture B-P53).

The jack handle is located in the storage area found under the driver side rear bed mounted on the outside wall, (see Picture B-P54).



Picture B-P53: Location of jack.



Picture B-P54: Location of jack handle.

## CONTINENTAL SPARE TIRE KIT:

To access full size spare tire:

1. Remove chrome ring and fiberglass disc.
2. While holding the spare tire, in the upright position, remove catch pin on the elbow of the receiver.
3. Slowly lower the spare tire to the flat position, (see Picture B-P56). Brace yourself for the weight of the tire, (40 kg / 80 lbs).
4. Remove lug nuts on spare tire to remove from carrier.

To store tire, repeat these steps in reverse.



Picture B-P55: Spare tire kit.



Picture B-P56: Remove from carrier.



Picture B-P57: Tire storage.

**CAUTION: WHEN THE FRONT, (60%) SIDE DOOR IS OPEN, (see Picture B-P58), THE FRONT PASSENGER CAB DOOR SHOULD NOT BE OPENED. OPENING THE CAB DOOR while the front side door is open MAY DAMAGE THE GROUND EFFECTS KIT.**

Home & Park Motorhomes makes no warranty whatsoever for damage caused to ground effects or doors as a result of this.



Picture B-P58: Front side door open.

Due to the properties of natural Maple wood, Home & Park makes no warranty against the mineraling of wood components, (see Picture B-P59).

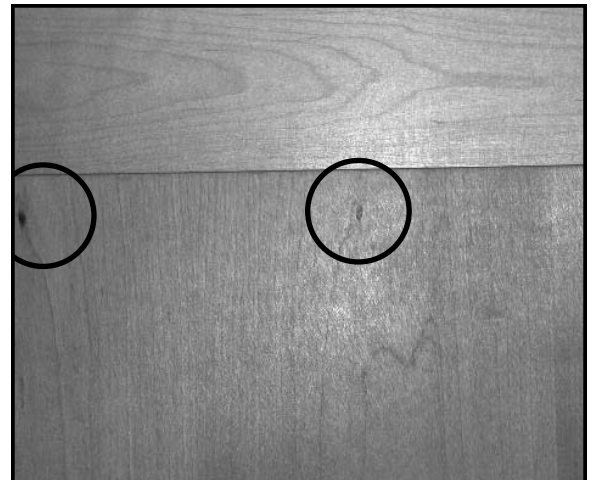

Picture B-P59: Mineraling in maple wood.



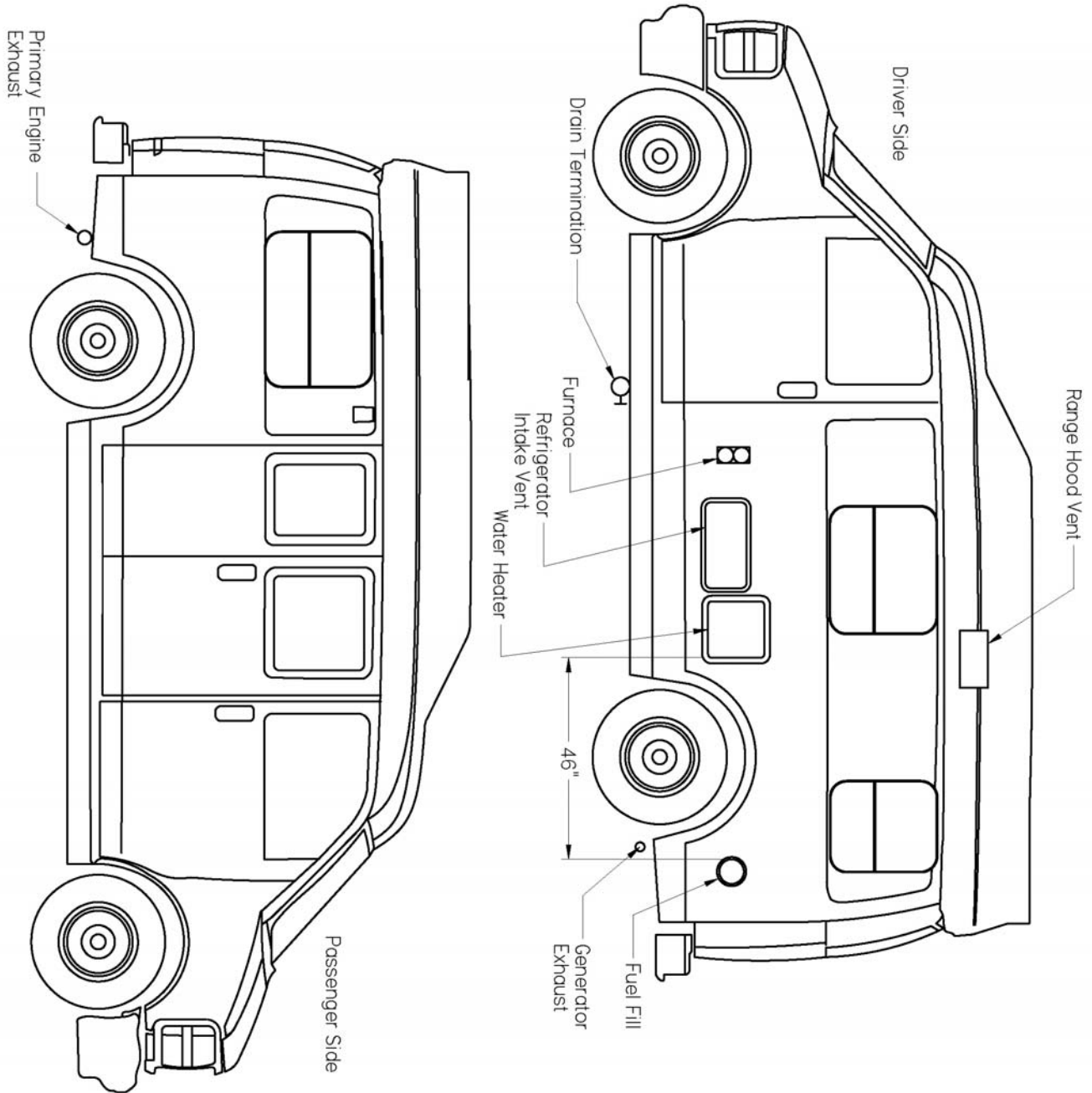

**170-Popular Chevrolet**

-INTERIOR FINISH MATERIALS HAVE A FLAME SPREAD RATING OF LESS THAN 200  
 -INTERIOR TEXTILE MATERIALS COMPLY WITH FMVSS 302  
 -INTERIOR DOORS/PARTITIONS ARE NON-LOCKING

CONTROL PANEL  
 1) Generator (Optional)  
 2) Battery Disconnect  
 3) Holding Tank & Water  
 Tank level gauge.  
 4) Water Pump  
 5) Patio Light

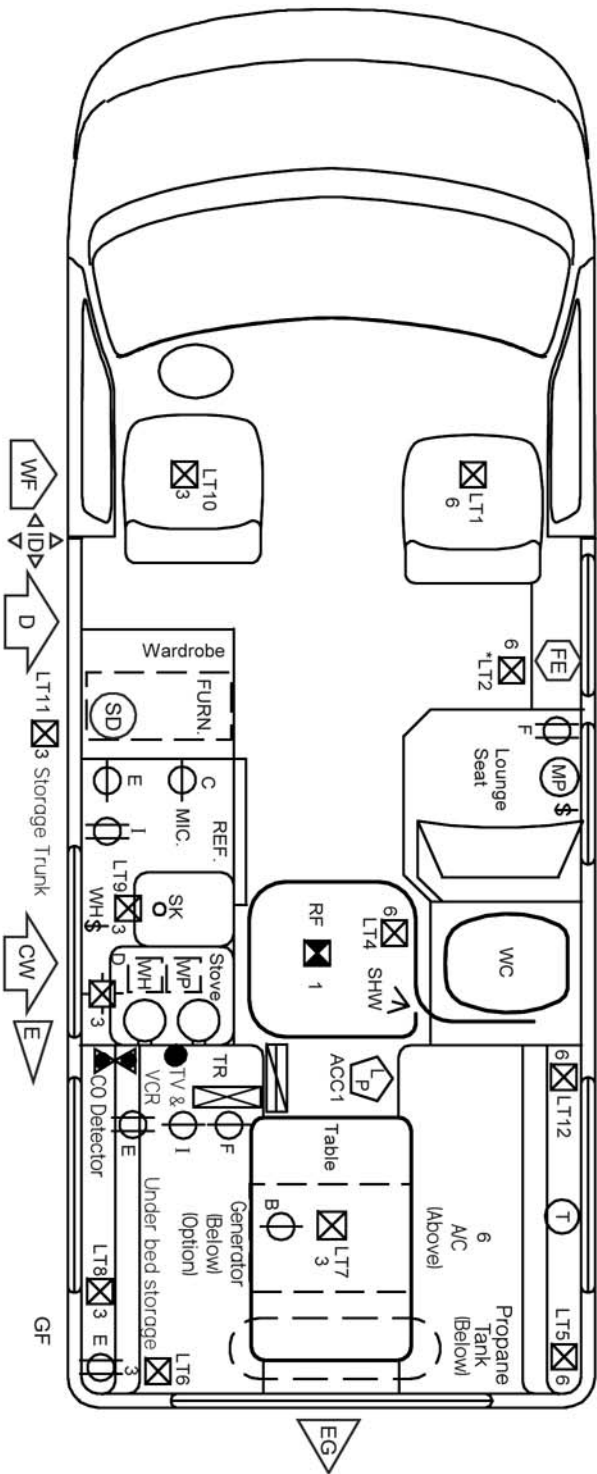

12	12	15	14AWG STANDARD CU	Roof Vent Fan, Rear and Patio Light
11	12	15	14AWG STANDARD CU	Roof Lights, Range Hood
10	12	10	14AWG STANDARD CU	Front, Galley and Rear Center Lights
9	12	15	14AWG STANDARD CU	AV (TV)
8	12	10	18AWG STANDARD CU	Heat pump (Air Conditioner)
7	12	10	14AWG STANDARD CU	Furnace
6	12	10	14AWG STANDARD CU	Water Heater
5	12	20	10AWG STANDARD CU	Refrigerator
4	12	1	18AWG STANDARD CU	CO Detector
3	12	1	18AWG STANDARD CU	Propane Gas Detector
2	12	10	14AWG STANDARD CU	Water Pump
1				
I	110	15	14AWG 2CU W/GROUND	AV Cabinet + Galley Receptacle
F	110	15	14AWG 2CU W/GROUND	Passenger side front + Inverter/charger Receptacle
E	110	15	14AWG 2CU W/GROUND	Driver side rear Receptacles, Refrigerator
D	110	15	14AWG 2CU W/GROUND	Water heater
C	110	15	14AWG 2CU W/GROUND	Microwave Receptacle
B	110	20	12AWG 2CU W/GROUND	Air Conditioner / heat pump Receptacle
A	110	30	10AWG 2CU W/GROUND	Main Power Switch
Circuit	VOLTS	AMPS	WIRE SIZE	LOADING

CIRCUIT SCHEDULE 17PC

## 170-Popular Chevrolet

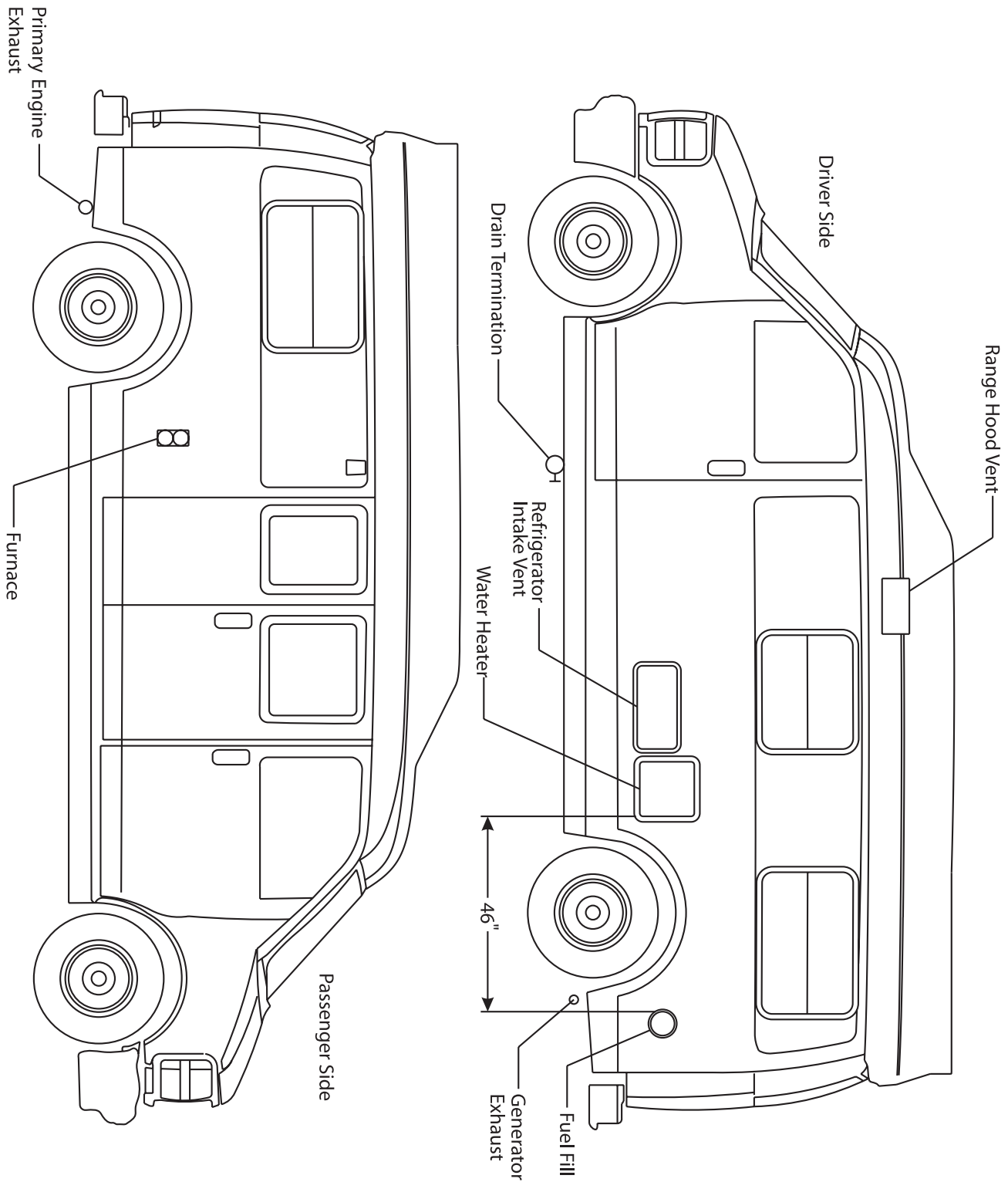

### 190-Popular Chevrolet

-INTERIOR FINISH MATERIALS HAVE A FLAME SPREAD RATING OF LESS THAN 200  
 -INTERIOR TEXTILE MATERIALS COMPLY WITH FMVSS 302  
 -INTERIOR DOORS/PARTITIONS ARE NON-LOCKING

- CONTROL PANEL
- 1) Generator (Optional)
  - 2) Battery Disconnect
  - 3) Holding Tank & Water Tank level guage.
  - 4) Water Pump
  - 5) Patio Light

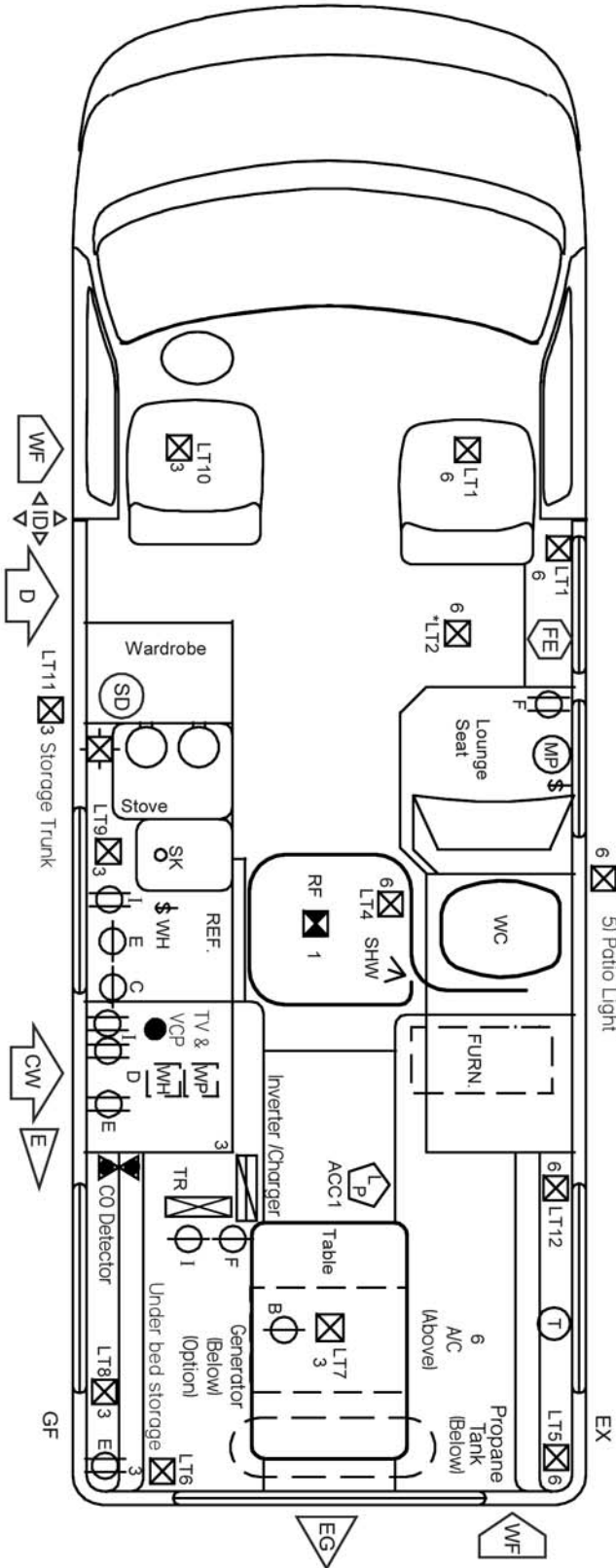

12	12	15	14AWG STANDARD CU
11	12	15	14AWG STANDARD CU
10	12	10	14AWG STANDARD CU
9	12	15	14AWG STANDARD CU
8	12	10	18AWG STANDARD CU
7	12	10	14AWG STANDARD CU
6	12	10	14AWG STANDARD CU
5	12	20	10AWG STANDARD CU
4	12	1	18AWG STANDARD CU
3	12	1	18AWG STANDARD CU
2	12	10	14AWG STANDARD CU
1			
1	110	15	14AWG 2CU W/GROUND
F	110	15	14AWG 2CU W/GROUND
E	110	15	14AWG 2CU W/GROUND
D	110	15	14AWG 2CU W/GROUND
C	110	15	14AWG 2CU W/GROUND
B	110	20	12AWG 2CU W/GROUND
A	110	30	10AWG 2CU W/GROUND
Circuit	VOLTS	AMPS	WIRE SIZE

CIRCUIT SCHEDULE 19PC

### 190-Popular Chevrolet

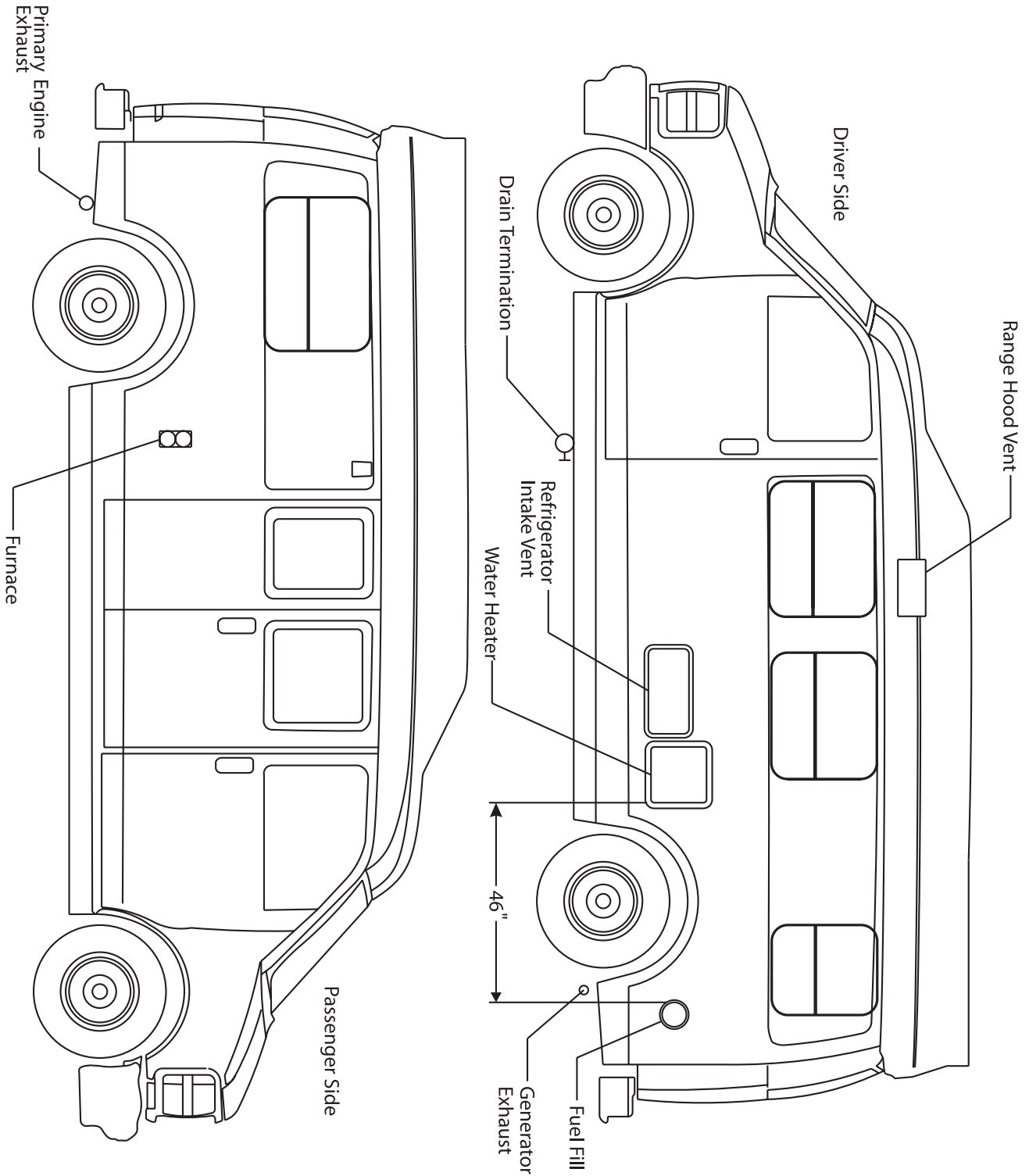

### 190-Versatile Chevrolet

-INTERIOR FINISH MATERIALS HAVE A FLAME SPREAD RATING OF LESS THAN 200  
-INTERIOR TEXTILE MATERIALS COMPLY WITH FMVSS 302  
-INTERIOR DOORS/PARTITIONS ARE NON-LOCKING

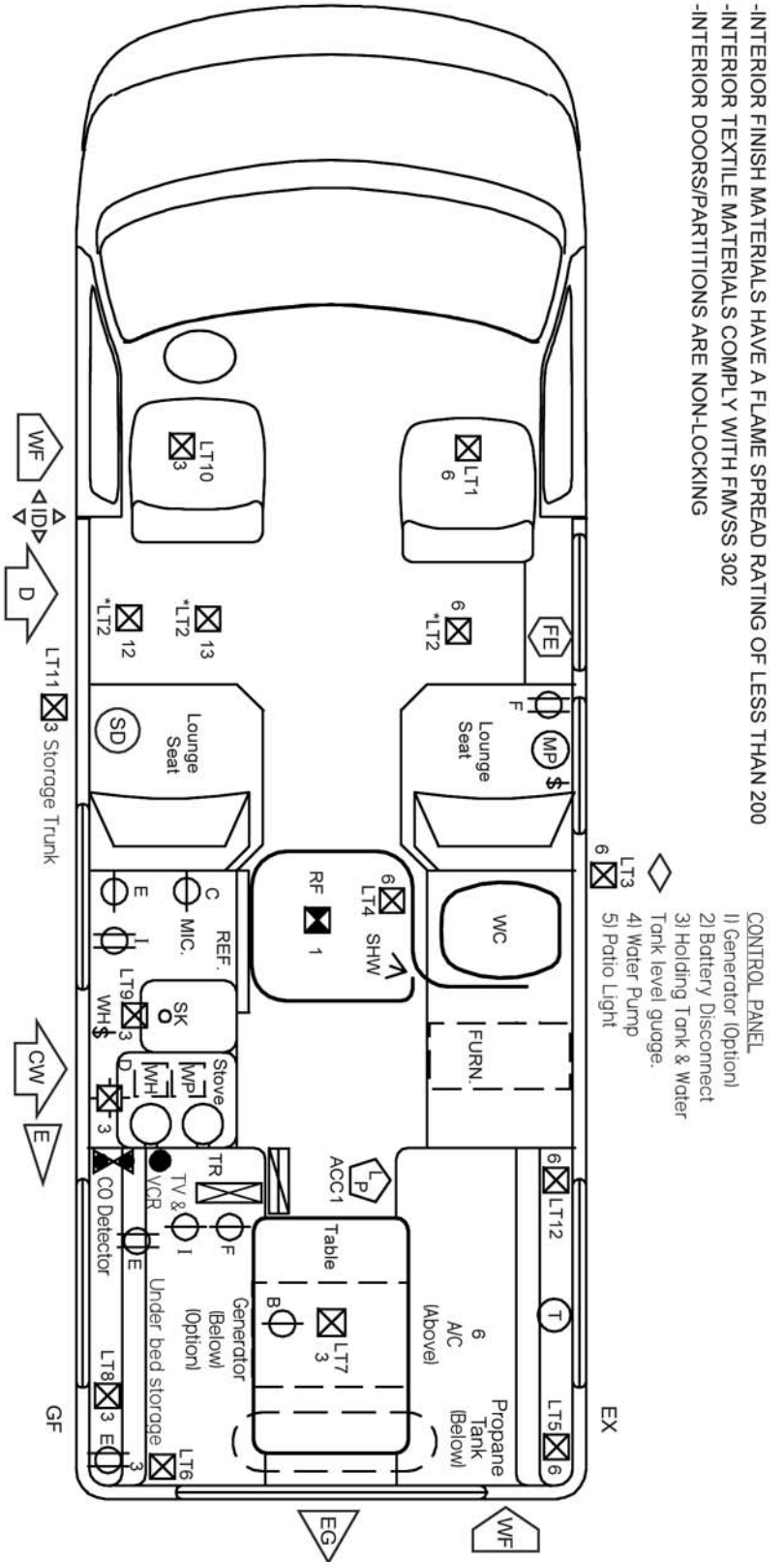

CONTROL PANEL

- 1) Generator (Optional)
- 2) Battery Disconnect
- 3) Holding Tank & Water
- 4) Tank level guage.
- 4) Water Pump
- 5) Patio Light

12	12	15	14AWG STANDARD CU	Roof Vent Fan, Rear and Patio Light
11	12	15	14AWG STANDARD CU	Roof Lights, Range Hood
10	12	10	14AWG STANDARD CU	Front, Galley and Rear Center Lights
9	12	15	14AWG STANDARD CU	AV (TV)
8	12	10	18AWG STANDARD CU	Heat pump (Air Conditioner)
7	12	10	14AWG STANDARD CU	Furnace
6	12	10	14AWG STANDARD CU	Water Heater
5	12	20	10AWG STANDARD CU	Refrigerator
4	12	1	18AWG STANDARD CU	CO Detector
3	12	1	18AWG STANDARD CU	Propane Gas Detector
2	12	10	14AWG STANDARD CU	Water Pump
1				
1	110	15	14AWG 2CU W/GROUND	AV Cabinet + Galley Receptacle
F	110	15	14AWG 2CU W/GROUND	Passanger side front + Inverter /charger Receptacle
E	110	15	14AWG 2CU W/GROUND	Driver side rear Receptacles, Refrigerator
D	110	15	14AWG 2CU W/GROUND	Water heater
C	110	15	14AWG 2CU W/GROUND	Microwave Receptacle
B	110	20	12AWG 2CU W/GROUND	Air Conditioner / heat pump Receptacle
A	110	30	10AWG 2CU W/GROUND	Main Power Switch
Circuit	VOLTS	AMPS	WIRE SIZE	LOADING

CIRCUIT SCHEDULE 19VC

## 190-Versatile Chevrolet

	POTABLE WATER FILL	●	T.V. JACKS	SK	KITCHEN SINK
	CITY WATER INLET	(T)	THERMOSTAT	TR	TRANSFER SWITCH
	POTABLE WATER PUMP	(M/P)	MONITOR PANEL	WC	WATER CLOSET
	DRAIN OUTLET	(M/A/C)	MACERATOR	WH	WATER HEATER
	INSIGNIA LOCATION		BATTERY STORAGE	WT	WATER TANK
	FIRE EXTINGUISHER (MIN. 10B.C.)		PROPANE DETECTOR		
	EMERGENCY EGRESS (17"x24" min.)	A/C	AIR CONDITIONER		
	MFG. ID LABEL	BAT	BATTERY CHARGE LEVEL INDICATOR		
	SMOKE DETECTOR	CM	COFFEE MAKER		
	CARBON MONOXIDE DETECTOR	EX	ENGINE EXHAUST		
	INVERTER / CHARGER	FURN	COMFORT HEATING APPL.		
	110V DISTRIBUTION PANEL	GEN	GENERATOR SET		
	12V FUSE BLOCK / BOX	GF	GASOLINE FILL		
	110V + 12V DISTRIBUTION PANELS	GFI	GROUND FAULT INTERRUPT		
	110V SINGLE RECEPTACLE	GFI/C	GROUND FAULT INTERRUPT CIRCUIT		
	110V DUPLEX RECEPTACLE	HT	HOLDING TANK		
	110V SPLIT DUPLEX RECEPTACLE	LAV	LAVATORY		
\$	SINGLE POLE SWITCH	PROPANE	PROPANE STORAGE TANKS		
\$	2 POLE DBL THROW SWITCH	MIC	MICROWAVE		
	12V LIGHT FIXTURE	RAN	COOKING APPLIANCE		
	12V EXHAUST FAN	REF	REFRIGERATOR		
	COMB. 12V FAN/LIGHT FIXTURE	RH	RANGE HOOD		
	120V ELECTRICAL INLET	SHW	SHOWER		

**LEGEND**  
 ROADTREK MOTORHOMES  
 SYMBOLS AND ABBREVIATIONS LEGEND

## 170 and 190 Chevrolet ROADTREK APPLIANCE & ACCESSORY MANUFACTURER'S LOG

<b>Appliance</b>	<b>Manufacturer</b>	<b>Model</b>
Awning	Fiamma	F45
Battery	Trojan	27TM
Battery Isolator	Herh-Powerline	33-22
CO Detector	MTI Industries	60-541
Distribution Panel	Progressive Dynamics	PD50K3Q2GP
DVD	RCA	
Fire Extinguisher	Company Kidde	Elite 10
Furnace	Suburban	NT 16SE
Generator	Onan	Microlite
Heat Pump	Dometic	41001.61
Inverter	Triplite	RU612ULH
Microwave oven	Dometic	CDMW07W
Monitor Panel	Kib	K42RT
Propane Detector	Electro Systems	GS/3
Propane Tank	Manchester	68001
Power Roof Vent	Fantastic	4000BT
Range	Elmel	SD2 Proprietary
Range Hood	Jensen	C610P1
Refrigerator	Dometic	RM2333R
Running Board Lock	Briggs & Stratton	702852 AB1
Satellite Antenna	Moto-Sat	Executive
Smoke Detector	Fire Sentry	0914CA
Toilet	Thetford	Aqua Magic IV Lo
Transfer Switch	Progressive Dynamics	PD5110610
TV	Samsung (Flat Screen)	510MP
Water Heater	Suburban	SW6DE
Water Pump	Shurflo	2088-403-144

**Appliance manufacturers and model numbers subject to change without notice**



**NOTE: INVERTER**

---

Your Owner's Manual for RV612ULHW contains most of the essential information you need to enjoy the electrical conveniences of home while at RV parks or dry camping. However, we wish to highlight for you exactly how the charging portion of the inverter/charger works, in order to help avoid possible confusion:

Supplying shore power or (optional) generator power enables RV612ULHW to charge the auxiliary battery (ies). Operation of your vehicle engine and alternator will also charge the auxiliary battery (ies). When your motorhome is not plugged-in to shore power or (optional) AC generator power, all electricity you use draws power from your motorhome's auxiliary battery bank, with the inverter allowing you to enjoy quiet DC-to-AC (12 volt to 120 volt) power in the absence of shore or generator power.

**10V inverter/charger shut down**

---

As a safety feature, the inverter component of the RV612ULHW inverter/charger (which changes DC battery power to AC electricity) will shut itself down when your auxiliary battery bank drops below 10 volts DC. This occurs in order to avoid excessive discharging and potential damage to the battery (ies), as well as to preserve sufficient battery voltage to maintain the functionality and readiness of the battery charger component of the RV612ULHW. It is possible, however, for the battery (ies) to become discharged below 10 volts DC as a function of activity other than using the inverter. For example, while dry camping, in the absence of shore or generator power, if a 12 volt appliance such as the fridge, furnace or lights are left on for an extended period of time. In that event, the battery charger component of the RV612ULHW will become inoperative. Therefore, after plugging into shore power or supply of (optional) generator power, it is possible that the battery (ies) may not be recharging. The indicators of this situation will be either completely dark LED lights on the monitor panel of the RV612ULHW inverter/charger, and a continuously blinking red LED light on the battery voltage readout, or all three LED lights continuously blinking on the battery voltage readout on the RV612ULHW.

**Inverter/charger start up after automatic safety shut down**

---

To remedy this situation, start the automotive engine, to allow the charger to sense a voltage of higher than 10 volts. The indicator of success will be a transition on the monitor panel from yellow inverted power LED light to the green line power illuminated LED light. This may take up to 60 seconds. At this point the engine can be turned off, because the charger has been activated and "takes over" the function of charging the battery (ies). Once battery voltage has risen sufficiently for your purposes (e.g., to the yellow, yellow-green, or green "full charge" level), shore power or (optional) generator power can be disconnected, although disconnection is not required; the charger will automatically reduce the rate of charge to prevent the battery (ies) from becoming overcharged.

**Dry camping battery conservation**

---

While dry camping, (no 110 VAC power available) to conserve battery power, it is recommended to switch the inverter to the off or charge position, if the inverter is left in the ON position, it will continue to draw 1.25 amps. To ease in switching of the inverter, we recommend installation of the optional remote switch and harness, (Part # APSRM4).

**Receptacle functionality**

---

When using your motorhome and connected to shore power or optional generator, the receptacles in the audio/video cabinet and in the galley will function to the 15 amp capacity supplied from the distribution panel. However when no shore power or option generator power is available, these receptacles are limited to the 600 watts, (6 amps) output from the inverter.

If an overload occurs, the inverter will shut down, and will need to be reset manually, by turning of the inverter off for 1 minute, removing the load, and then turn the inverter back on.

Your vehicle's electrical system should not be subjected to changes and / or additions to circuitry, appliances, etc. without consulting your dealer or Home & Park for proper installation procedures.

Failure to do this could result in serious safety issues or component damage. Changes to the electrical system run the risk of voiding the warranty.

### **120 / 12V INVERTER / CHARGER / DISTRIBUTION PANEL:**

---

For your convenience when camping in parks with hookups for 110V power, all our models have in the electrical system a 110/12 volt distribution panel / inverter / charger. The inverter/charger provides 12 volt power for the 12 volt appliances and the inverter provides 110 volt power for the galley receptacle and the audio/video receptacle. The inverter charger also charges auxiliary batteries present in the system.

See "Floor Plan & Appliance Location" for the distribution/inverter/charger location. To open the distribution panel simply pull the access door until the cover is released. All the 110 volt breakers and 12 volt fused circuits are identified inside the distribution panel, behind the distribution panel access door.

### **EXTERNAL ELECTRICAL SOURCE CONNECTION:**

---

Your vehicle is equipped with a heavy duty 30 amp. power cord so that you can connect your electrical system to an outside 110V power source.

The power cord is stored in the storage compartment located behind the driver side large lockable middle access door integrated within the running boards, (see Pictures B-P30 and B-P32).

**NOTICE: Do not place heavy or sharp objects on the power chord.**

A 30 to 15 amp. adapter is not included with your vehicle.

**NOTICE: When connecting your system to an external power source, ensure that a properly equipped, (three pronged) and functioning receptacle is used. If any type of spark or shock is detected, disconnect from the source immediately and do not reconnect until the problem is corrected.**

### **GENERATOR:**

---

All service requirements are listed in the generator owners manual.

The generator is located and accessed on the underside behind the rear axle of your vehicle.

**CAUTION: When launching a boat, using your Roadtrek, it is important to know that generators must not be submerged in water.** This will permanently damage the generator. If you cannot launch without submerging the generator, an alternate method would be to use a boat launching service.

**Notice:** To prevent carburetor damage, generator must be run for a minimum of 20 minutes under load monthly.

### **BUILT-IN 110V HEAT PUMP - AIR CONDITIONER:**

---

In addition to the operating instructions contained in the Manufacturer's Owner's Manual, the air conditioner - heat pump should be started as follows when the optional generator is used:

1. Start the generator and run for several minutes until warm.
2. Set thermostat setting above ambient temperature.
3. Turn thermostat control to the "low cool" position.
4. Turn fan to the ON position.
5. Adjust the thermostat cooler until the compressor starts.
6. Once compressor is running adjust the thermostat to desired setting. Your vehicle should be parked as close to level as possible to maximize the air conditioner's efficiency.

**NOTE:** The heat pump may be used to warm up the motorhome on cool nights. For colder temperatures, below 40°F, (4°C) it is suggested that the furnace be used for heat.

## TV:

**WARNING:** If your vehicle is equipped with an optional flat screen TV, the TV must be off and in the stored position during travel.

## MONITOR PANEL:

A monitor panel is located on the shelf above the passenger lounge seat, (see Picture E-P1).

The monitor panel is used to provide the approximate fluid levels in the fresh, grey and black (holding) water tanks, the propane tank, and the charge level of the auxiliary battery.

The monitor panel has a series of L.E.D. lights that mark the fluid levels at set increments of F (full), 2/3, 1/3 and E (empty). Therefore with respect to the water tank levels, you must be aware that the panel does not always reflect the actual fluid levels. For example, when the 1/3 level light is on, the tank may be anywhere from 1/3 to just under 2/3 full. When the panel reads empty, the tank may be anywhere from empty to just under 1/3 full.

The black and grey water tanks must be flushed regularly with sanitation fluid, to prevent the accumulation of solids on the probes to maintain accurate black and grey water level readings. Required tank flushing will vary depending on usage.

To flush: Refer to the instructions on the Waste Tank Dumping found in the Water Systems Section.

**NOTE:** When the water system is operating in the winter mode, only the interior fresh water tank is to be used. Therefore you must be aware that the interior tanks fluid level is actually empty when the 1/3 L.E.D. light is displayed on the monitor panel.

The auxiliary battery charge level indicator is marked "C", "G", "F", and "L".

1. "C" indicates the battery is fully charged.
2. "G" indicates the battery charge is "good".
3. "F" indicates "fair".
4. "L" indicates "low".

The battery condition is indicated by the uppermost light that is on. For example, if the "G", "F", and "L" lights are on, the battery charge is "Good".

The panel also provides the switch for the water pump and a disconnect switch for the auxiliary battery.



Picture E-P1: Monitor panel, porch light and optional generator control switch.

---

**AUXILIARY BATTERY AND ISOLATOR:**

The auxiliary battery is a group 27 lead acid battery. The auxiliary battery is located behind the passenger side access door found behind the rear wheel, see section on Auxiliary Battery. To access the battery refer to the auxiliary battery section found in the Daily Living section.

The auxiliary battery is automatically charged through the isolator by the engine's alternator while the engine is running. This battery is also automatically charged by the inverter / charger when:

1. The battery disconnect switch on the monitor panel is set to the "ON" position prior to connection to an outside electrical power source.
2. Your vehicle is connected to an outside electrical power source.
3. The breakers in the distribution panel are in the "ON" position.
4. While the generator is in operation, (if equipped).

A disconnect switch, located on the monitor panel, provides a disconnect for the auxiliary battery from the 12V system while your vehicle is not in use.

Since the auxiliary battery is a deep-cycle type, it may be discharged completely and recharged without damage, (whereas the automotive battery is designed to be kept fully charged by the alternator and may undergo damage if fully discharged). However, a battery should never remain in a discharged state and should be recharged immediately to prevent damage. When not in use, the auxiliary battery will slowly discharge on its own.

Accordingly, if the battery is not being used, it should be recharged monthly by connecting to an outside electrical power source, by operating the generator, (if equipped) for at least 12 hours, or by running your vehicle's engine for a minimum of 2 hours.

The **isolator** is located under the hood in the engine compartment. The isolator allows the alternator to charge both the automotive and auxiliary batteries when the engine is running, and it will prevent your vehicle's 12V motorhome equipment, (interior lights, water pump, exhaust fans, furnace blower, etc.) from drawing on the automotive battery.

---

**AUTOMOTIVE BATTERY:**

The automotive radio in your vehicle will exert a small draw on the automotive battery to maintain the time and preset stations.

**To prevent the battery from being completely discharged, the radio should be disconnected from the automotive battery when your vehicle will be out of service for 2 months or more. Failure to do this may risk voiding the warranty.**

The radio can be disconnected by removing the 10 amp. radio fuse from the automotive fuse block, located at the left underside of the dash, or by disconnecting the negative automotive battery cable. See Automotive Owners Manual for full radio operating instructions.

---

**INTERIOR CAB LIGHT :**

The interior 12V cab light located on the underside of the cab ceiling panel has a multipurpose switching system. This switching system utilizes the switch on the light itself and the dash mounted headlight switch, located to the left of the steering wheel.

Refer to the Chevrolet's Owner's Manual for complete operation instructions.

---

**RANGE HOOD EXHAUST FAN:**

The range hood exhaust fan should be on while the propane stove is in operation.

The operation switches for the fan and light are located on the face of the fan.

---

**WATER HEATER :**

The Roadtrek is equipped with a dual mode water heater. The water heater may be operated by 110V power or propane. Please refer to the Suburban owner's manual for complete operation instructions.

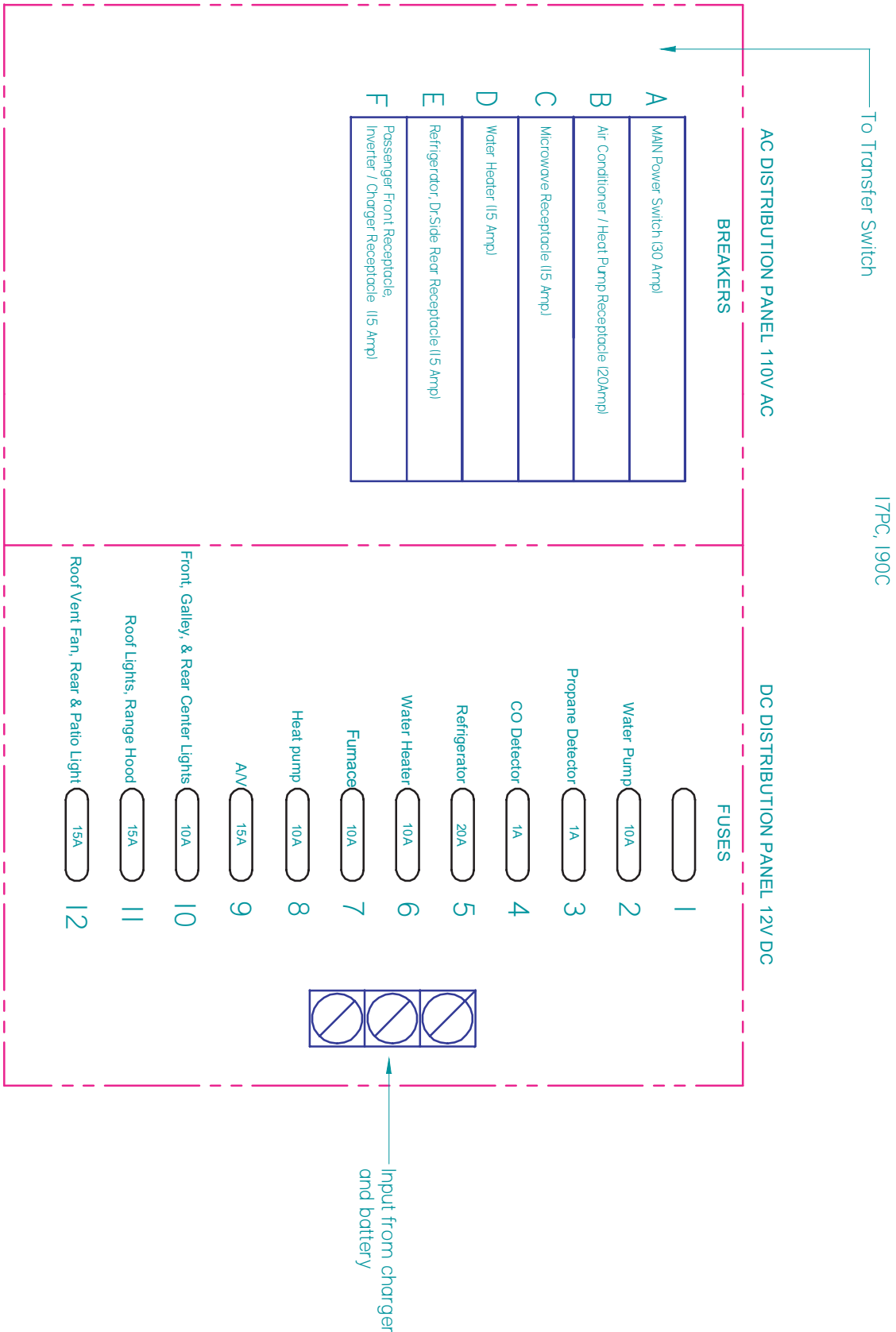

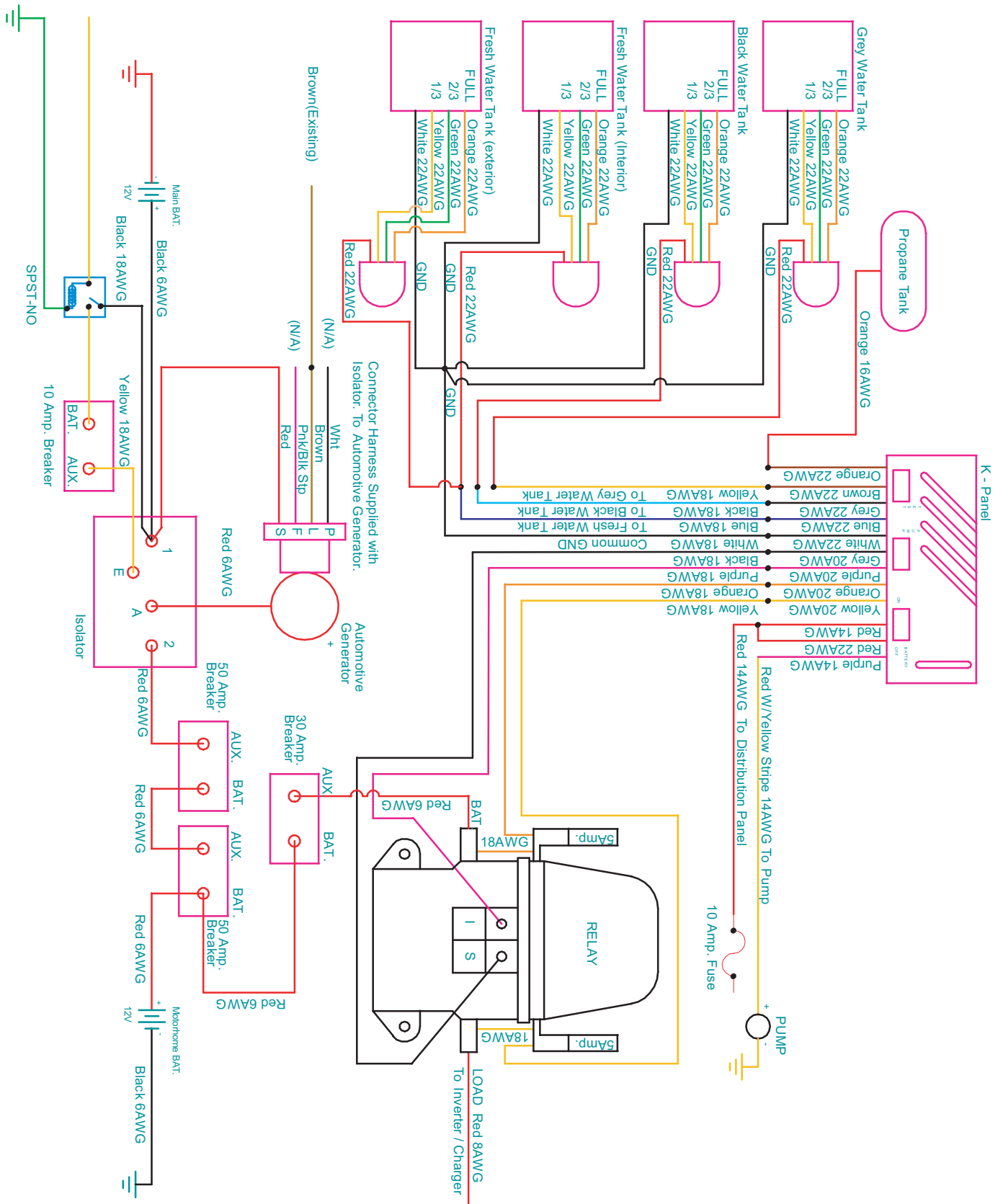

**170-Popular Chevrolet**

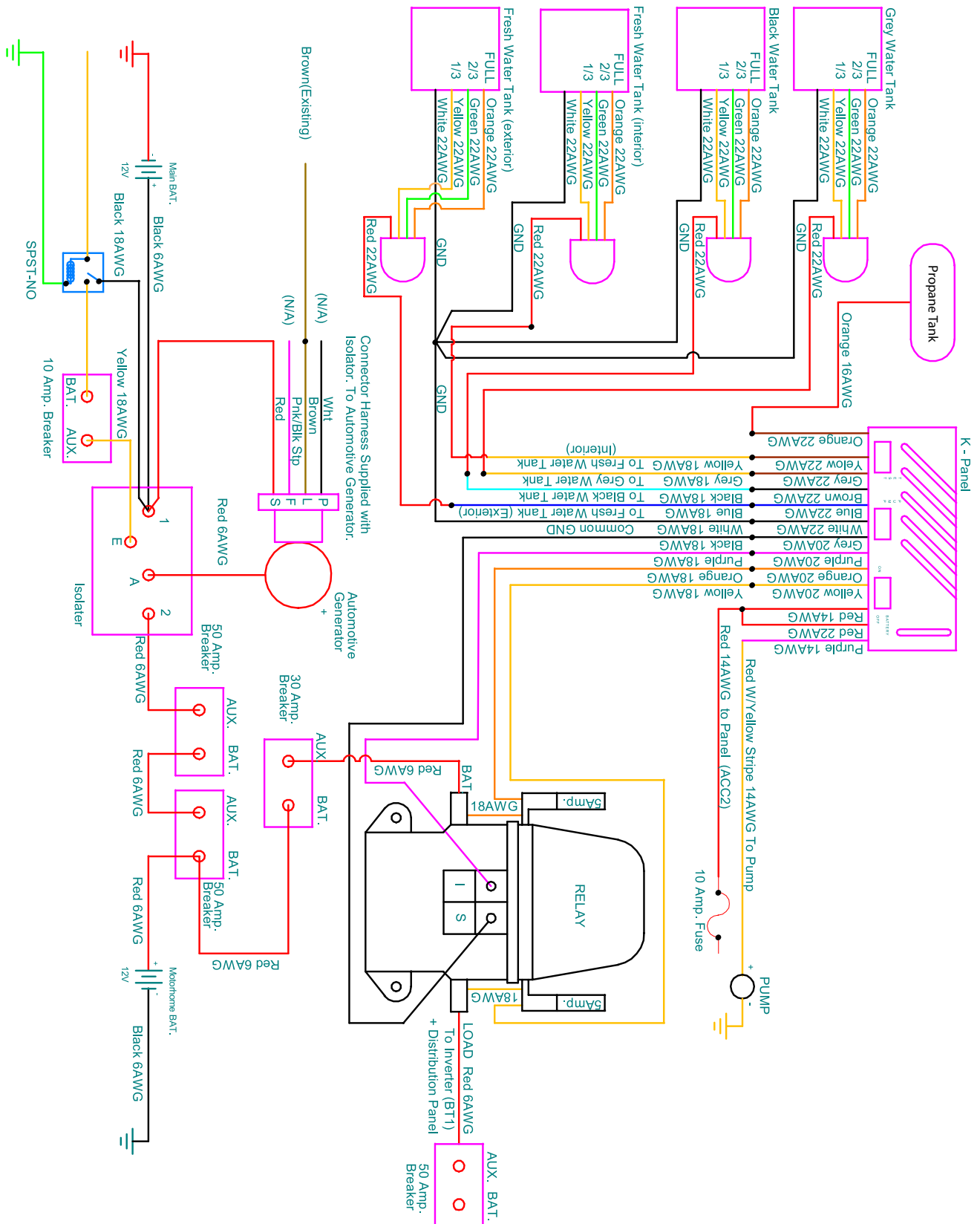

**190 Chevrolet Models**

**CHEV**

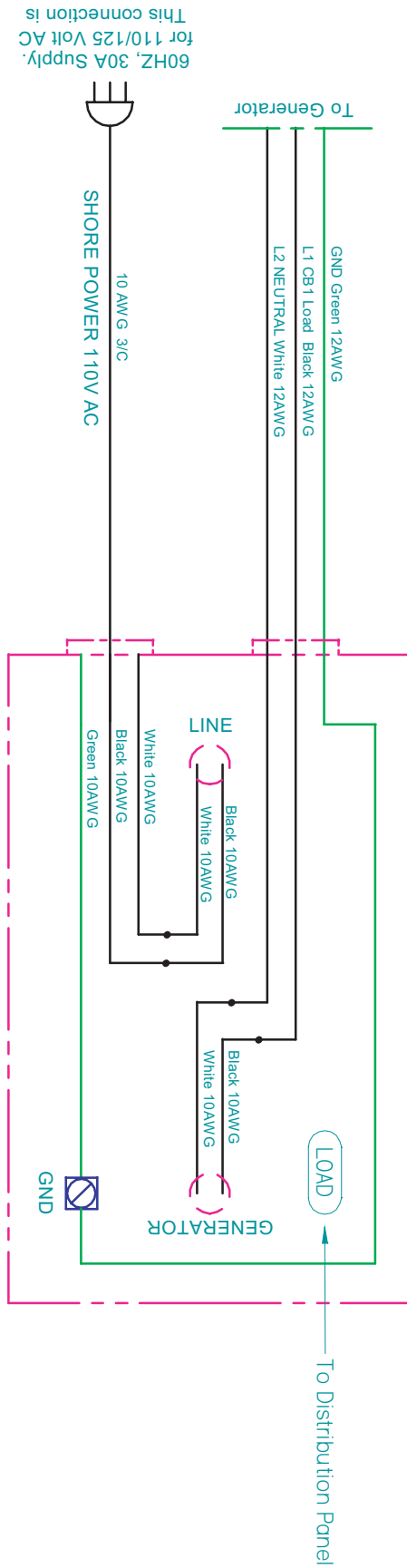



Your vehicle is equipped with a propane system which, when properly handled and maintained, will provide trouble and worry free operation of your propane fueled appliances.

Propane fuel is stored in a liquid state under extremely high pressure. As fuel is used, propane passes from the top of the tank through the regulator into the gas lines and eventually to the appliances.

Although the entire system has undergone extensive factory and dealer testing for leaks, the system's connections and fittings are subjected to road vibrations and therefore **should be checked annually for possible leaks.**

Propane fuel is extremely flammable, colourless, heavier than air and smells like garlic or rotten eggs.

IF YOU SMELL GAS, extinguish any open flames, pilot lights and smoking materials immediately. Do not touch any electrical switches. Leave vehicle, shut off the propane supply at the tank valve and open doors and windows to provide maximum ventilation. Leave the area until the odor clears. Have the system checked and the leak corrected before use.

Propane fuel must be turned ON to operate propane fueled appliances.

**WARNING:** Propane tanks shall not be placed or stored inside your vehicle. Propane tanks are equipped with safety devices which relieve excessive pressure by discharging gas to the atmosphere.

**WARNING:** To reduce the danger of fire or explosion do not store gasoline or other flammable liquids inside your vehicle.

**WARNING:** Ensure you purchase propane from a reputable propane facility. Contaminated propane is a common cause of system failure.

**WARNING:** Follow all recommended maintenance schedules.

## **PROPANE TANK:**

---

To open and close the propane tank use the manual tank shutoff valve located on the tank, accessible from behind the rear bumper.

It is recommended to close the propane tank shutoff valve when the vehicle is not in daily use. Further, it is recommended to close the shutoff valve when the vehicle is in travel.

The refrigerator should be operated on 12 volt when the vehicle is in travel. See refrigerator Manufacturers Owner Manual for proper 12 volt operation.

## **APPLIANCES:**

---

**WARNING:** It is not safe to use cooking appliances for space heating purposes due to the danger of asphyxiation.

**WARNING:** The propane stove needs fresh air for its safe operation.

Because the amount of air supply is limited by the size of your vehicle, before operating the propane stove, open the overhead vent or a window and then turn on the range hood for increased air circulation, (see Floor Plan & Appliance Location). Proper ventilation when using the propane stove will reduce the dangers of asphyxiation.

**WARNING:** Portable fuel burning equipment, including wood and charcoal grills and stoves, should not be used inside your vehicle. Use of this equipment inside your vehicle may cause fire or asphyxiation.

See appropriate component Manufacturer's Owner's Manuals for operating instructions.

## **REFUELING PROCEDURES:**

---

**WARNING:** Do not refuel the propane tank to more than 80% of its capacity.

A properly refueled propane tank will hold approximately 80% of its volume in a liquid state. Over fueling of the propane tank can result in uncontrolled gas flow which can cause fire or explosion.

**WARNING:** The tank valve must be closed and **ALL PILOT LIGHTS, APPLIANCES, AND THEIR IGNITERS, (see Operating Instructions) SHALL BE TURNED OFF** during refueling of motor fuel tank and / or the propane tank. Only qualified personnel should refuel your propane tank.

## **REGULATOR:**

---

The propane regulator is located adjacent to the propane tank.

This regulator has been installed in a protective cover to keep out debris, and with the vent facing downward. Ensure that the regulator vent always faces downward to minimize vent blockage which could result in excessive gas pressure causing fire or explosion.

**PROPANE LEAK DETECTOR:**

Your vehicle has been equipped with a propane leak detection device for your protection, (see Picture F-P1).

See "Floor Plan & Appliance Location" for location of the propane leak detector location.

Be sure the detector is operating while using your vehicle.

**Do not block air circulation in the area where the propane leak detector is located.**

See Manufacturer's Owner's Manual for other operating instructions.

**WARNING:** Battery disconnect switch must be in the "ON" position for detector operation.



Picture F-P1: Propane leak detector.

**CARBON MONOXIDE LEAK DETECTOR:**

Your vehicle is equipped with a carbon monoxide, (CO) leak detection device for your protection, (see Pictures F-P2 and F-P3).

See "Floor Plan & Appliance Location" for location of the carbon monoxide gas leak detector location.

Be sure the detector is operating while using your vehicle.

Do not block air circulation in the area where the carbon monoxide leak detector is located.

See Manufacturer's Owner's Manual for other operating instructions.

**WARNING:** Battery disconnect switch must be in the "ON" position for detector operation.



Picture F-P2: Carbon monoxide leak detector, (Popular models).



Picture F-P3: Carbon monoxide leak detector, (Versatile models).

**SMOKE DETECTOR:**

Your vehicle is equipped with a smoke detection device for your protection, (see Picture F-P4).

See "Floor Plan & Appliance Location" for the smoke detector location.

This device should be tested after each time your vehicle has been in storage, before each use, and at least once each week during your vehicle's use.

**NOTE:** Upon delivery of your vehicle from the factory, the detector is inoperative because the battery is reversed to prevent drainage. Before operation, reverse the battery to the proper position and test the operation of the detector.

Be sure the detector is operating while using your vehicle.

Do not block air circulation in the area where the smoke detector is located.

See Manufacturer's Owner's Manual for operating instructions.

**NOTE:** Cleaning products may contaminate safety detectors. Detectors should be covered when using cleaning chemicals on the vehicles interior.



Picture F-P4: Smoke detector.



Maximum developed length: 211"  
Maximum Btu/hr input: 42,080

Lines to be grommeted when they pass through structural material.  
2 Plcs.

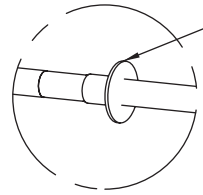

**DETAIL B**

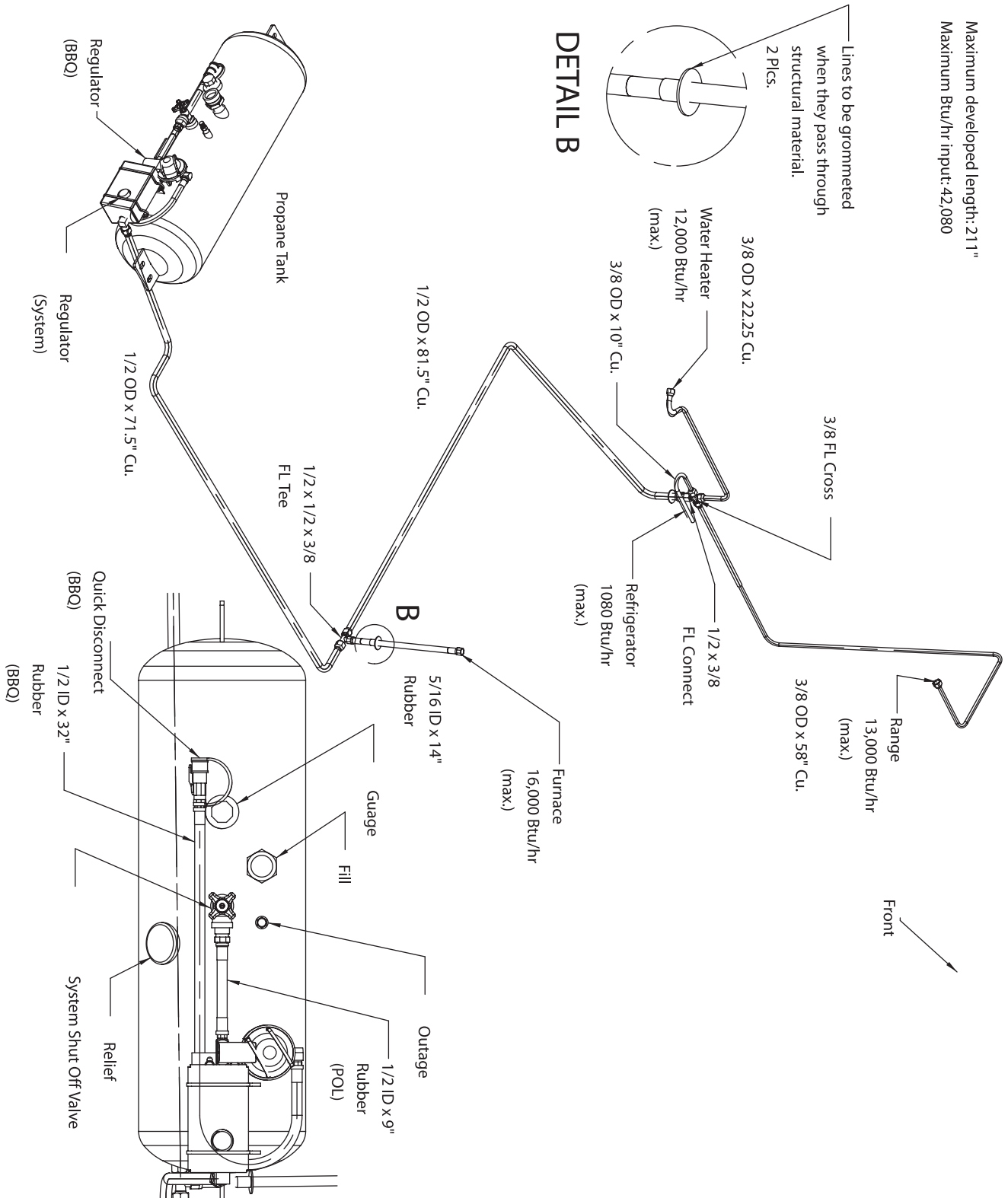

**190-Popular Chevrolet**

Maximum developed length: 21'1"  
Maximum Btu/hr input: 42,080

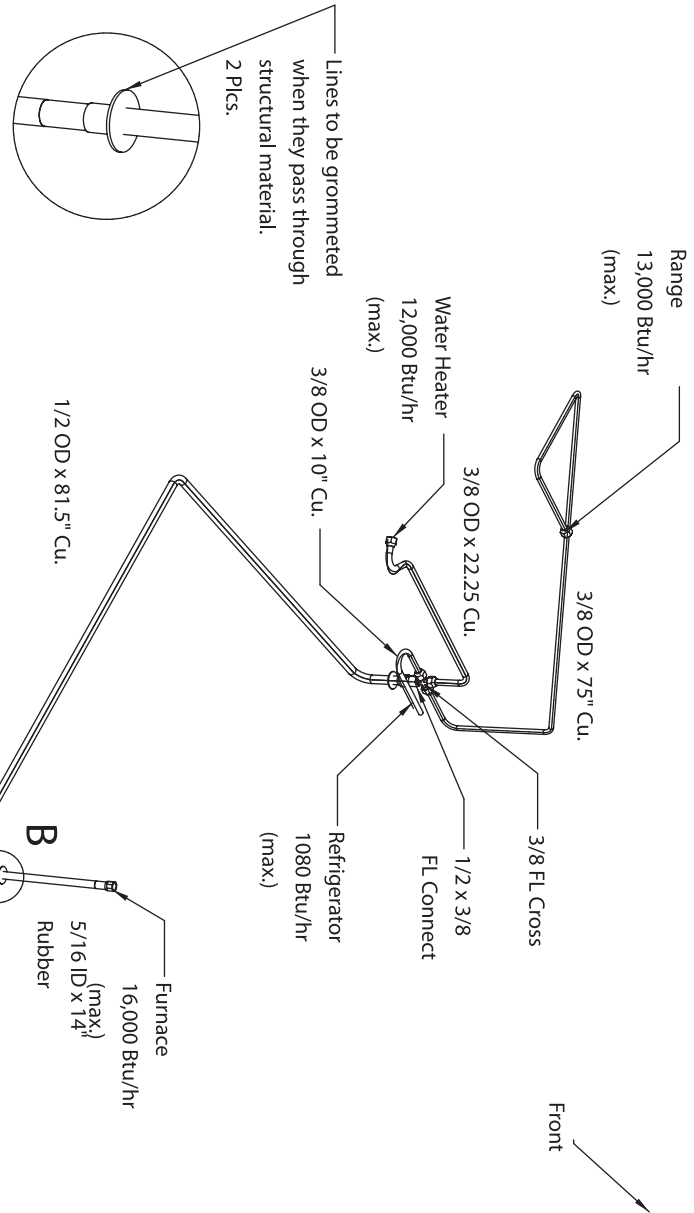

**DETAIL B**

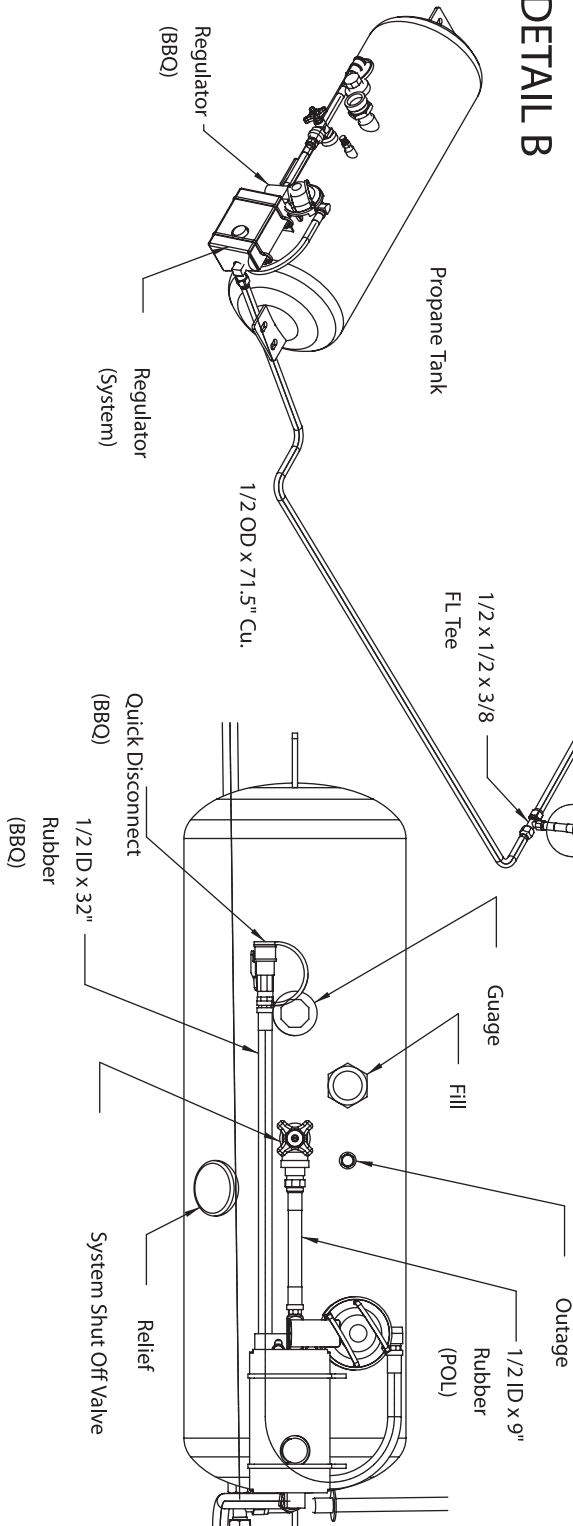
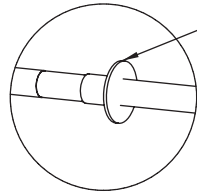

**190-Versatile Chevrolet**

190 models are equipped with dual fresh water tanks. One tank is located in the vehicles interior, the other tank is located on the vehicles exterior. 170 models are equipped with an exterior fresh water tank only.

The purpose of the dual tank system is to provide a separate fresh water system that can be used in sub moderate freezing conditions.

The system can only function properly in either one of two modes. Summer use or winter use. All procedures to change operation modes must be followed for proper operation.

Your vehicle is equipped with a water system for either completely self contained or fully dependent use. It is not equipped with a pressure regulator to compensate for varying water pressure levels.

During self contained use, caution should be taken so as to minimize water consumption. For example, water consumption can be reduced while showering if you turn off the shower between wetting down and rinsing off.

To avoid damage due to road vibrations, be sure not to store heavy or sharp objects where they may come into contact with either the water lines or water pump. Also, allow sufficient room around the pump for proper operation.

### **FILLING THE INTERIOR FRESH WATER TANK (190 Models only):**

The interior fresh water tank can be filled through the gravity fill located on the passenger side of the rear door opening, (see Picture G-P1). To fill the interior tank:

1. Open the rear passenger door.
2. Open the gravity fill cover by removing the orange plug, (see Picture G-P1).
3. Insert the hose and fill the tank using moderate pressure, (excessive pressure will result in a back flow of water).
4. When the tank is full, water will overflow back through the gravity fill hole.
5. Overfilled tanks will spill out through tank vents. This is evidenced by water dripping from the rear passenger side corner of van.

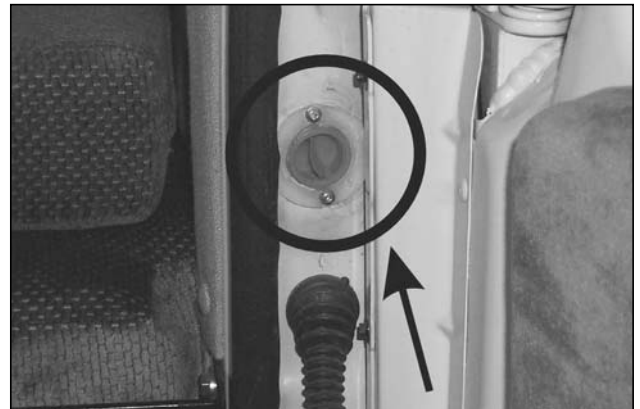

Picture G-P1 : The gravity fill, (rear door post, 190 models only).

### **FILLING THE EXTERIOR FRESH WATER TANK (All Models):**

1. Open the front driver side door.
2. Open the gravity fill cover by removing the orange plug, (see Picture G-P2).
3. Insert the hose and fill the tank using moderate pressure, (excessive pressure will result in a back flow of water).
4. When the tank is full, water will overflow back through the gravity fill hole.
5. Overfilled tanks will spill out through tank vents. This is evidenced by water dripping from the underside of the van.



Picture G-P2 : The gravity fill, (front driver door post, on all models).

The fresh water tanks can also be filled through the city water inlet located behind the large lockable driver side middle access door, for location, see the Daily Living section. The use of the city fill is not possible when in the winter operation mode.

To fill the tank:

1. Prior to using city fill ensure water system is in summer operation mode, (see mode switching). Connect a hose to the city water inlet connection, (see Picture G-P3).
2. To fill the fresh water tanks, open the city water tank fill shut off valve, (see Picture G-P4).
3. Open the water source moderately.
4. When the tank is full, water will overflow in the same manner as when using the gravity fill, (see previous page).
5. Close the city water tank fill shut off valve, (see Picture G-P5).

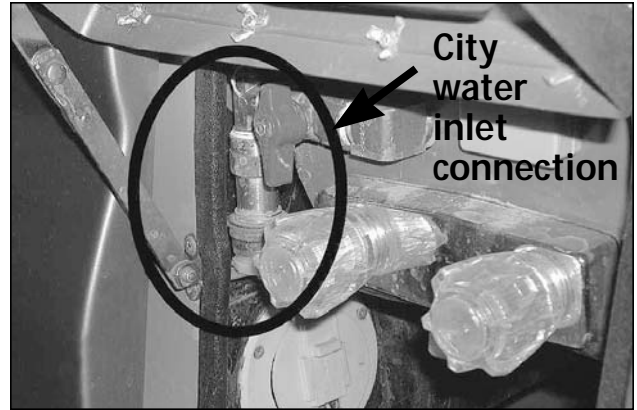

Picture G-P3: Location of the city water inlet connection.

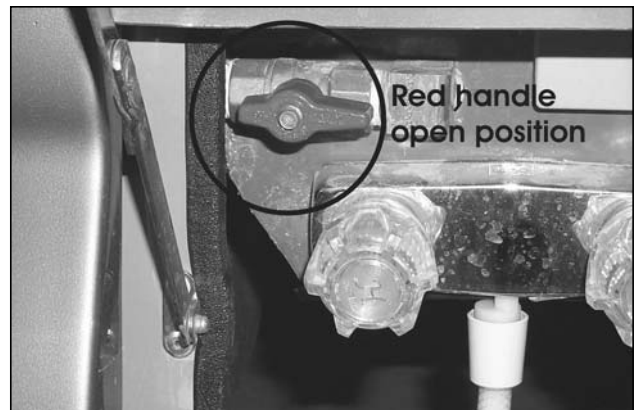

Picture G-P4: Open position of the city water tank fill valve.



Picture G-P5: Closed position of the city water tank fill valve.

**CITY WATER CONNECTION:**

**NOTE:** City water connection can only be used in summer operation mode. This supplies the 190 models with dual water tank system.

The city water inlet connection is located in the small compartment behind the large lockable driver side storage compartment, (see Picture G-P3). To connect the water system to an outside source:

1. Ensure that the water pump is turned off.
2. Close the city water tank fill valve by turning the handle to the vertical position, (see Picture G-P5).
3. Be sure that all interior faucets are closed to prevent spillage.
4. Open the city water source slowly to prevent excessive water force inside your vehicle. (To protect your system from excessive pressure from water supply systems encountered in some areas, a water pressure regulator should be used. Such a regulator is not supplied with your vehicle).
5. Note that this connection by-passes the water pump and fresh water tank. Therefore, the use of these items is not necessary when connected directly to an external water source.



To disconnect the city water connection:

1. Turn off the external water source.
2. Open the sink faucet to relieve the pressure in the system, (failure to do so may result in an unexpected shower).
3. Ensure that the city water tank fill valve is closed, (see Picture G-P5).
4. Remove the hose from the city water connection, replace the cap on fill connection.

### **WASTE WATER STORAGE AND DUMPING SYSTEM:**

Your vehicle is equipped with a waste water storage and dumping system that will provide adequate and effective storage and dumping of waste water. Your vehicle should be as level as possible to allow optimal operation of the system.

**CAUTION:** Ensure that both the black and grey water gate valves are closed, (inward position) before using the waste water system. This applies especially after extensive driving. Black and grey water dump valves are accessed through the small access door located just to the rear of the driver side door.

Support the door in the open position by using the support arm, (see Picture G-P7).

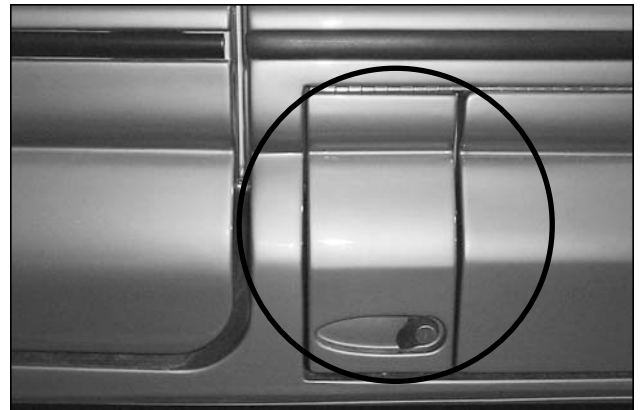

Picture G-P6: Driver side storage door.

### **Waste Water Tank Preparation:**

Your vehicle is equipped with two waste water tanks, the grey waste water tank is for waste water from the sink and aisle shower and the black waste water tank is for sewage from the toilet. Both tanks are equipped with separate dump valves so that each may be dumped independently. Before use of either waste tank, be sure to read instructions provided by the toilet manufacturer regarding waste water chemicals. We suggest that such chemicals be used every time to minimize build up of solids on water level sensors inside the tanks.

**CAUTION:** During winter use under moderate subfreezing conditions, (refer to pages G.9-G.12) antifreeze is required in the exterior black and grey waste water tank. Antifreeze should be used at a 50-50 ratio.



Picture G-P7: Access to sewer discharge assembly, black and grey gate valve handles.

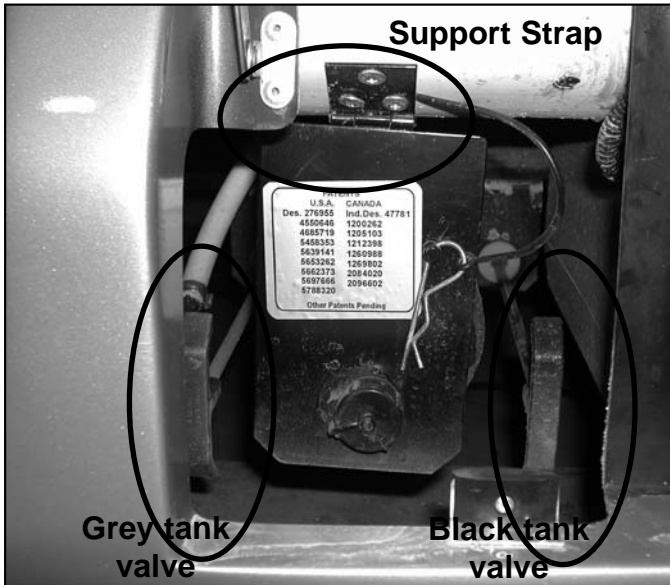

Picture G-P8: Proper driving location of support strap.



Picture G-P10: Removal of the end cap.

### Waste Water Tank Dumping:

To dump the exterior black waste water tank:

1. Remove support strap retainer pin and lower sewage hose.
2. Connect the dump fitting, (stored in the storage compartment behind the large access door), to the end of the assembly.
3. Securely place the dump fitting and assembly in the local waste receptacle.
4. Pull the black water gate valve handle, (to open) to dump the tank contents.

To dump the grey waste water tank:

1. Follow the same procedure using the grey water gate valve handle located in front of the sewage discharge assembly.
2. Be sure to dump the grey waste water tank last so as to help flush out any solid waste in the sewage hose from the black waste water tank.
3. Once the tanks are empty, close the gate valves, remove the fitting, return the assembly to its support structure and ensure that all caps and supports are securely in place.
4. If desired, flush both waste tanks after dumping.

**NOTICE:** It is recommended to always dump the black water tank first, then the grey water tank.

**CAUTION: WHEN FINISHED DUMPING THE BLACK AND GREY TANKS AND THE ASSEMBLY IS TILTED BACK TO ITS STORAGE POSITION. INSERT RETAINER PIN TO PREVENT THE ASSEMBLY FROM FALLING WHILE DRIVING, (see Picture G-P8).**

Home & Park Motorhomes makes no warranty what so ever for damage caused to the sewage discharge assembly as a result of this.

## Waste Water Tank Flushing:

---

To flush the waste water tanks:

1. Ensure that both tanks are empty.
2. Fill the black waste water tank by inserting a hose into the toilet, **(be sure to step on the flush pedal, so the flapper door stays open to prevent toilet overflow)** and the grey waste water tank using the sink.
3. Dump both tanks using the procedure outlined above.

Both waste water tanks can also be flushed using a similar procedure, but rather than filling each tank using the potable water system, they can be filled by inserting a hose directly into the sink and toilet.

## OUTSIDE SHOWER:

---

**NOTE:** Outside shower can only be used in summer operation mode.

The outside shower faucet is found in the small compartment behind the large driver side storage compartment, (the shower hose is stored in the large compartment). Remove the shower hose from the storage compartment and attach to the faucet spout, (see Picture G-P11). The shower hose must be returned to the storage compartment before travel as to prevent damage to the unit.

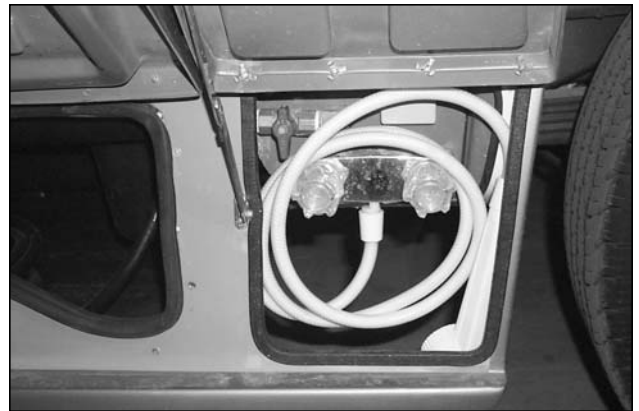

Picture G-P11: Outside shower. Shower hose storage when Motorhome is **parked**.

## POTABLE WATER SYSTEM DRAINING:

---

**NOTE:** Water system must be in summer operation mode.

To completely drain the fresh water system of all water:

1. Ensure that the water pump is off and that your vehicle is level.
2. Ensure that the interior tank valve is in the open position.
3. Drain the fresh water tank and the hot and cold fresh water system by opening the exterior fresh water drain valve at the low point drain, (see Pictures on page G-9).
4. Open all water outlets including the sink faucet, aisle shower faucet, external shower faucet, and toilet flushing pedal. The latter can be propped open or opened manually several times. This procedure allows gravity to draw any remaining water out through the tank drains.
5. Your vehicle is equipped with a water heater, follow the manufacturer's instructions for draining.
6. Open the sink faucet and turn on the water pump until water is no longer pumped.
7. Turn off the water pump.

If this procedure is followed, it is unnecessary to blow out the water system. Once the system is drained, be sure to close all taps before driving.

**NOTE:** Do not allow water to sit in tank when vehicle is not in use.

## **POTABLE WATER SYSTEM SANITIZING:**

---

**NOTE:** Water system must be in summer operation mode, (190 models).

Your potable water system should be sanitized if it is new, has not been used for a period of time, or may have become contaminated.

To sanitize your system:

1. Prepare a chlorine solution using 4 L, (1 gallon) of water and 60 ml, (1/4 cup) of household bleach, (5% sodium hypo chlorite solution).
2. With the fresh water tank empty, (see section on Waste Water Tank Flushing), pour, (see section on Filling Fresh Water Tank), 4 L, (1 gallon) of solution into the tank for each 60 L, (15 gallon) of tank capacity. As an alternative, several commercial solutions are available and should be used as directed on the package.
3. Complete filling of the tank with fresh water.
4. Turn on the water pump and slowly open all faucets to release trapped air.
5. Close faucets and allow to stand for 3 hours then drain and flush with fresh potable water.
6. To remove excessive chlorine taste or odor which may remain, prepare a solution of 1 L, (1 quart) vinegar to 20 L, (5 gallons) water and pour into tank and allow solution to agitate in tank by vehicle motion, (several days if possible).
7. Drain tank and flush with fresh potable water.

## **WATER SYSTEM WINTERIZING:**

---

**NOTE:** Water system must be in summer operation mode and repeat operations 5 and 6 with water system in winter operation mode, (190 Models).

To winterize your potable water system:

1. Drain the entire system including water heater, (refer to water heater manual for instructions on draining).
2. Place water heater by-pass in the by-pass position to prevent water heater from filling with antifreeze.
3. Add 8 L, (2 gallons) of approved nontoxic recreational vehicle antifreeze to the interior and exterior fresh water tanks using both gravity fills.
4. Turn on the water pump.
5. Open all three faucets until antifreeze is visible.
6. Open the toilet valve until antifreeze is visible. Refer above to the water system winterizing **NOTE**.
7. Turn off pump.
8. Disconnect and drain the P-traps of the sink and aisle shower. Shower P-trap is located on your vehicle underside to the rear of the waste water tanks.

To prepare your potable water system for use:

1. Drain the antifreeze from the system.
2. Sanitize the system if desired.
3. Fill the system with water.

**WINTER MODE VALVE POSITIONS (190 Models only):**

---

1. Outside shower faucet, (Hot and cold cutoff valves mini valves), - Closed, (see Picture G-P20).
2. Tank selector valve must be closed, (interior tank position see G-P13, exterior tank position see Picture G-P12).

**SUMMER MODE VALVE POSITIONS:**

---

1. Outside Shower Faucet, (Hot and cold cutoff mini valves), - Open, (see Picture G-P19).

The valve modes for the fresh water system must be configured completely in one or the other of summer or winter modes as detailed above.

- In winter mode
- Use gravity fill only.
  - No outdoor shower.
  - Waste water tanks are unprotected from freezing unless charged with antifreeze.
  - Interior temp must be maintained above 65°F, (18°C) .
  - Fridge must be turned ON.
  - Exterior fresh tank must be drained.
  - Exterior shower and city fill must be drained.

**WINTER USE: (Moderate Subfreezing Conditions, -10°C (14°F)) (190 Models only)**

---

The dual tank system allows you to use the fresh water system under moderate subfreezing conditions by allowing you to isolate and drain the exterior fresh water tank and the exterior shower faucets.

To prepare your motorhomes fresh water system for winter use you must do the following:

Ensure you first turn off the water pump, (switch is found on the monitor panel) before isolating and draining the exterior fresh water tank.

Switch tank selector valve to winter position, (see Picture G-P13).



Picture G-P12: Selector valve supply from the exterior fresh water tank.



Picture G-P13: Selector valve supply from the interior fresh water tank.

Your Roadtrek is equipped with a water heater by-pass valve. When it is in summer mode, all three valves will face the aisle, (see Picture B-P14). In winter mode, the water line valve is open and the valves at the water heater are closed, (see Picture B-P15).

To isolate and drain the outside shower when using the fresh water system in moderate subfreezing conditions the shower cutoff valves must be closed.

To close the shower cutoff valves:

1. Remove cushions from driver side rear bed.
2. Open water heater access cover, (see Picture G-P16).
3. Locate the hot and cold water cutoff valves, (see Picture G-P18).
4. To isolate the exterior shower faucets the cutoff valves must be turned 90°, (cross line), (refer to Pictures G-P19 and G-P20 for the open and closed positions of the isolator valves).
5. Open the shower faucets in order to drain the exterior water lines, (reclose after draining exterior tank).
6. For summer use of the fresh water tanks repeat the steps in reverse.

**NOTE:** When the water system is operating in the winter mode, only the interior fresh water tank is to be used. Therefore you must be aware that the interior tanks fluid level is actually empty when the 1/3 L.E.D. light is displayed on the monitor panel.



Picture G-P14: Summer mode valve positions.



Picture G-P15: Winter mode valve positions.



Picture G-P16: Location of the access door for the tank selector valve.



Picture G-P17: Water heater access door.

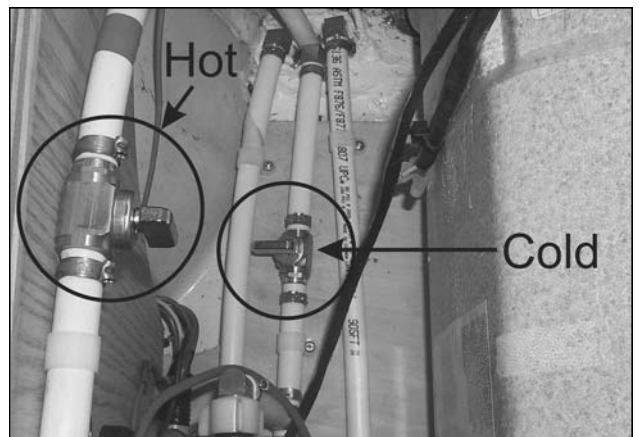

Picture G-P18: Hot and cold water cutoff valves.

**PLEASE NOTE: On Versatile models the water heater and tank selector valves are located in the lower galley cupboard.**



Picture G-P19: Hot water cutoff valve in open position.



Picture G-P20: Hot water cutoff valve in closed position.

To drain the exterior fresh water tank you must open exterior drain valve at the low point drain located below the drivers side front door running board, (for 190 models see Picture G-P21, for 170 model see Picture G-P23).

Ensure that the exterior shower faucet valves are open and that the city water inlet valve has been emptied of water. After tank is drained close exterior shower faucet valves and exterior fresh water tank valves.

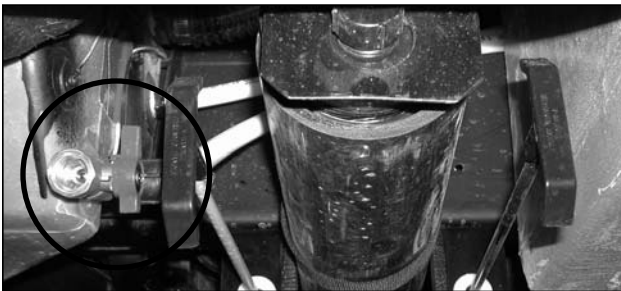

Picture G-P21: Location of the exterior freshwater tank drain.

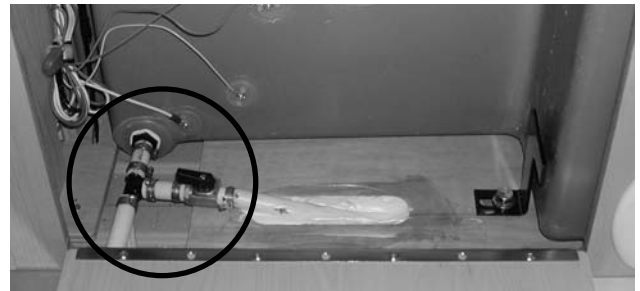

Picture G-P22: Interior tank drain valve in open position.



Picture G-P23: Exterior fresh water drain valve, (170 model).

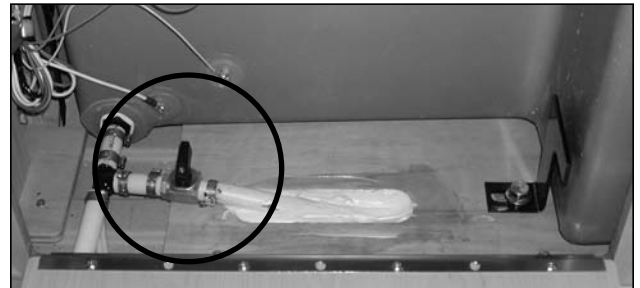

Picture G-P24: Interior tank drain valve in closed position.

## TO DE-WINTERIZE:

Repeat the steps in reverse order.

**NOTE:** By using antifreeze in the black and grey waste water tanks, the waste water system can be used in moderate subfreezing conditions.

Although the waste and fresh water systems have been designed for use in moderate subfreezing conditions. Home & Park Motorhomes makes no warranty what so ever for damage to the water systems as a result of freezing.

To prevent interior water lines from freezing, it is recommended that the interior temperature be maintained at +65°F, (18°C).

**WATER SYSTEMS**

Note:  
All piping is listed 1/2" PE-X with listed fittings and connectors unless otherwise specified. The City water inlet includes a 3/4" female swivel hose connector with cap.

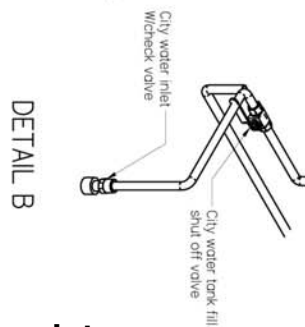
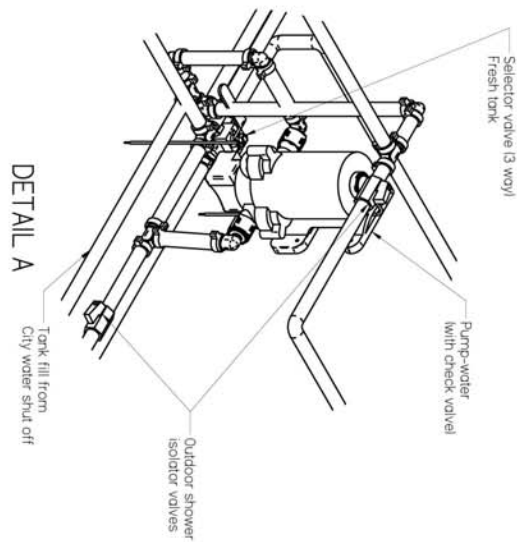
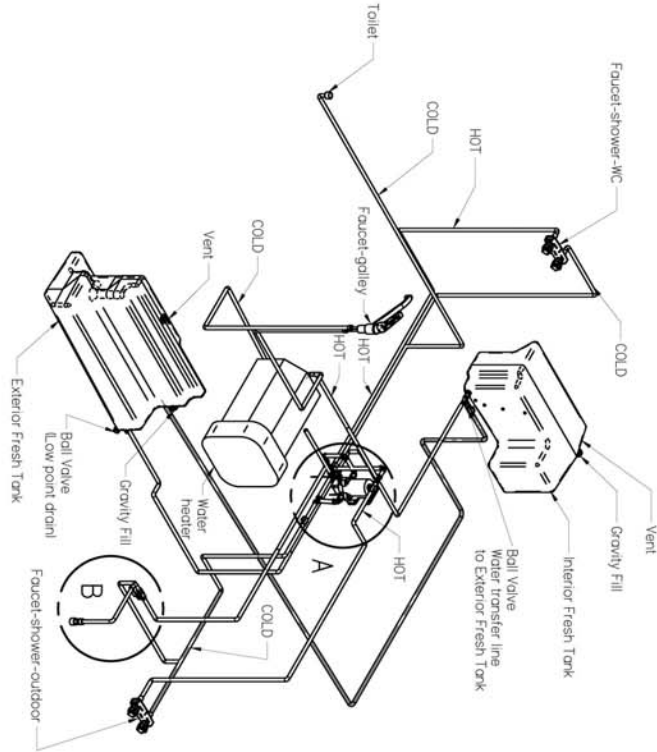

**190 Chevrolet**











---

**EXTERIOR MAINTENANCE:**

---

To maintain the original appearance and finish, your vehicle's exterior body and roof must be waxed at least annually. If deterioration, such as tarnishing or chalking, should occur, apply a mild rubbing compound and wax to restore the original appearance.

---

**EXTERIOR WASHING:**

---

To prevent water from entering your vehicle, avoid spraying water directly into exterior vents or grills. Use care and caution when using a power washer to prevent water leaks. Do not point power washer directly towards any door openings, body seams, vent or automotive striping.

---

**OTHER MAINTENANCE:**

---

For necessary maintenance of other components and appliances, see their respective manufacturer's owner's manuals for instructions.

---

**WINTER STORAGE:**

---

---

**INSIDE YOUR VEHICLE:**

---

Before winter storage:

1. Be sure to clean your vehicle thoroughly. Special emphasis should be given to the appliances, such as the refrigerator.
2. Once cleaned, leave the refrigerator door propped open with the cutting board in the freezer compartment to prevent the development of odors, (insert a box of baking soda if desired).
3. Open a window slightly allowing sufficient air circulation to avoid the development of odors, condensation and mildew.
4. To prevent sun rays from deteriorating and fading interior fabrics, cover all upholstered seats and cushions. As a further precaution, close all drapes tightly.
5. Disconnect the auxiliary battery using the disconnect switch located in the monitor panel.

---

**OUTSIDE YOUR VEHICLE:**

---

Before winter storage:

1. Ensure that all waste water tanks have been dumped and flushed and that the entire potable water system has been properly drained, refer to sections on Potable Water System Draining and Potable Water System Winterizing.
2. Be sure to cover the external vents to the refrigerator, exhaust fan, furnace and air conditioner, (if equipped) with heavy plastic sheeting to prevent entry by rodents and insects.
3. To improve tire life and maintain performance, put your vehicle up on blocks. Also, cover all tires exposed to sun light to prevent deterioration from ultraviolet rays.
4. Consult your automotive owner's manual or local automotive dealer regarding steps necessary to prevent engine and chassis damage during long periods of storage in your particular region.

**SPRING START UP:**

---

After storage, reactivate your vehicle for use by reversing all the procedures that you performed to prepare it for winter storage. In addition, propane system's connections and fittings should be checked for possible leaks and all other systems and appliances should be operated to ensure satisfactory performance.

**TIRES:**

---

See the automotive chassis manufacturer's owner's manual and documents for tire warranty and recommended inflation pressures.

**CARGO CARRYING CAPACITY:**

---

See the information labels attached to the driver door post, inside of lower galley cabinet door, and insert at the back of this manual.

**OWNER MAINTENANCE CHECKS:**

---

Listed below are vehicle maintenance checks and inspections that should be performed by the owner or qualified service technician at the indicated intervals.

Any adverse conditions should be brought to the attention of your dealer or qualified service technician for expert service advice as soon as possible.

The owner maintenance checks are generally not covered by warranties and you may be charged for labor, parts and supplies used.

**WHEN YOU STOP FOR FUEL:**

---

Extinguish all pilot lights.

Check engine oil level.

Look for low or under inflated tires.

**AT LEAST MONTHLY:**

---

Check coolant level in the coolant recovery reservoir.

Check operation of all exterior lamps, including brake lamps, turn signals and hazard warning flashers.

Check tire pressure.

Run generator for 20 minutes under load to prevent carburetor damage.

**AT LEAST ONCE EVERY THREE MONTHS:**

---

Flush black water holding tank.

Flush grey water holding tank.

Flush and sanitize fresh water tank.

**AT LEAST TWICE A YEAR:**

---

- Check power steering fluid level.
- Check windshield washer level and wiper operation. Clean wiper blades with clean cloth dampened with washer fluid.
- Check radiator, heater and air-conditioning hose for leaks or damage.
- Check for worn tires and loose wheel lug nuts.
- Check parking brake system.
- Check head lamp alignment.
- Check lap and shoulder belts for wear and function.
- Check air pressure in spare tire.
- Inspect appliance vents to ensure they are free from dirt, insects, spider webs and/or nests.
- Inspect black and grey water tank vents.
- Clean air conditioner filter.
- Thoroughly clean and wax the roof of the van.

**AT LEAST ONCE A YEAR:**

---

- Lubricate all door hinges, locks and latches.
- Clean battery terminals (automotive and coach).
- Have propane test completed by certified gas technician.
- Have appliances tested and cleaned.
- Wax & polish and protect exterior surfaces.

**AUXILIARY BATTERY:**

---

Your vehicle is equipped with a group 27 lead acid auxiliary battery. It is recommended that acid levels be checked at least once every 3 months, every 1 month under heavy usage.

See battery manufacturers maintenance recommendations.

**In order to maintain the function of the slide out battery tray you must lubricate the slides and compartment bottom. Use of a general automotive grease is recommended. It is recommended that this be done every 3 months when you are checking the acid levels.**

The above maintenance schedule is a recommendation only. Please refer to your Chevrolet Manual for details on the Chevrolet required maintenance schedule.

Efficient economical vehicle performance will be enhanced by utilizing this recommended maintenance. It is strongly recommended that no repairs be made with out appropriate training, tools and safety equipment. This could cause bodily injury, damage to the vehicle or cause the vehicle to operate improperly.

Home & Park shall not be held liable or assume any obligations or responsibilities whatsoever for any loss, damage or injury directly or indirectly caused by, arising or resulting from, or as a consequence of the use or nonuse of the information contained herein or the operation or non-operation of any items mentioned herein. And, finally, Home & Park shall be indemnified and saved from all losses, expenses, claims and demands whatsoever.

**ALUMINUM WHEEL MAINTENANCE:**

---

Never clean your wheels when they are hot! either from free standing in the sun, or from normal road use.

Always clean wheels when they are cool to the touch of your hand. If you spray any type of cleaning agent, corrosive or not, they will stain a polished and chrome wheel and even some clear coated wheels. Period. No matter how expensive they are!

Clean your wheels either early in summer mornings or dusk on summer evenings, a good practice is not to clean them in direct sunlight. We are experiencing different UV and ambient temps, from a result of a changing ozone. This also plays havoc on tires too!

Clean rims using mild soap and water, some strong cleaning agents will spot polished wheels every time.

Avoid car washes if possible when your wheels are hot, this could stain the wheel.

In time, due to brake and regional temps in North America, the wheels will fade from their luster, so from time to time, use a premium polish wheel cleaner/polish to keep the natural polished finish look.

Never use steel wool or coarse abrasive pads to clean ANY wheel, it will cause permanent damage, and will not be warranted by the wheel manufacture.

It is recommended to place Vaseline, or some type of oil based cooking grease and coat the wheels during the harsh winter and touch them up from time to time or have a set of winter wheels and tires!



## LIMITED WARRANTY DEFINITIONS

---

Home & Park Home & Park Motorhomes (A Division of HANMAR MOTOR CORPORATION).

<b>Dealer</b>	Dealer or any wholesale buyer of recreational vehicles, authorized by <b>Home &amp; Park</b> .
<b>Vehicle</b>	Any recreational vehicle manufactured by <b>Home &amp; Park Motorhomes</b> .
<b>Purchaser</b>	Registered owner of the <b>Vehicle</b> and/or purchaser of the <b>Vehicle</b> .
<b>Warranty Card</b>	Home & Park Limited Warranty Registration Card specifying <b>Purchaser</b> of <b>Vehicle</b> .

All vehicles are covered by a three part limited warranty: Automotive Warranty, Appliance Warranty, and Home & Park Limited Motorhome Warranty.

## HOME & PARK LIMITED WARRANTY REGISTRATION CARD

---

**It is very important that the Dealer complete the Home & Park Limited Warranty Registration, (at the bottom of the "QualityCare" Pre-Delivery Report) on each Vehicle and fax it to Home & Park within 48 hours from the date of retail delivery.** Home & Park uses the information on the Limited Warranty Registration to:

1. Notify General Motors to start the automotive (chassis) warranty in the Purchaser's name as of the date of retail delivery.
2. Maintain records for the Home & Park Limited Motorhome Warranty and for any recall notifications.

If Home & Park does not receive this information, when the Purchaser tries to have automotive warranty work done, the Purchaser, the Dealer and Home & Park will be severely inconvenienced until this information is received and processed by General Motors.

## AUTOMOTIVE WARRANTY - GENERAL MOTORS ( CHEVROLET CHASSIS)

---

The warranty currently offered by General Motors covers the manufacture of the Chevrolet chassis. See the General Motors Warranty Information booklet for details.

For Chevrolet chassis sold through **RV dealers**, Home & Park uses the information on the completed Warranty Card to notify General Motors to **restart the automotive (chassis) warranty** in the Purchaser's name as of the date of retail delivery. Upon receipt of the Warranty Card, Home & Park completes and mails the appropriate forms to General Motors who in turn enter this information into their computer systems. This process can take up to 6 weeks from when the Dealer mails the Warranty Card. If warranty work is required before this process is completed and the Vehicle's V.I.N. appears on the computer, the Purchaser should ask the Chevrolet dealer to enter the Purchaser's name and address and date of retail delivery into the computer. To prove the vehicle is still under warranty, the Purchaser should show a copy of the bill of sale to the Chevrolet dealer.

If Home & Park does not receive the completed Warranty Card, when the Purchaser tries to have automotive warranty work done, the Purchaser, the Dealer and Home & Park will be inconvenienced until this information is received and processed by General Motors.

## **AUTOMOTIVE WARRANTY - GENERAL MOTORS ( CHEVROLET CHASSIS)**

---

For Chevrolet chassis sold through **Chevrolet dealers**, the Dealer will enter the appropriate information directly into General Motors' computer system to **restart the automotive (chassis) warranty** in the Purchaser's name as of the date of retail delivery.

All automotive service, maintenance and repairs are to be performed by any Chevrolet dealer. See the General Motors Warranty Information booklet for details. Such items are not warranted by Home & Park. **Home & Park will pay for the removal and reinstallation of motorhome components necessary to perform automotive recalls and warranty** for 36 months or 36,000 miles (in US) or 60,000 Km (in Canada), which ever occurs first, from date of purchase by the first Purchaser. After this period such costs are considered to be inherent in the ownership of such a vehicle. **Home & Park will not pay for the removal and reinstallation of motorhome components necessary to perform automotive service or maintenance.** Such costs are considered to be inherent in the ownership of such a vehicle.

## **LIMITED WARRANTY INFORMATION**

---

The following information must be provided when contacting the factory for warranty:

Selling Home & Park Dealer: \_\_\_\_\_

Address: \_\_\_\_\_ Phone: (\_\_\_\_) \_\_\_\_\_

City, State/Prov: \_\_\_\_\_ Zip/Postal Code: \_\_\_\_\_

V.I.N.(last 8 digits): \_\_\_\_\_ Sales order #(Located On The Driver Door Post Label): \_\_\_\_\_

Date Of Delivery To Owner (Retail Purchaser): \_\_\_\_\_

## **AUTOMOTIVE CUSTOMER SERVICE & ROADSIDE ASSISTANCE NUMBERS**

---

Chevrolet (US) customer service	800-222-1020
Chevrolet (US) roadside assistance	800-CHEV-USA (243-8872)
GM Canada customer service	800-263-3777
GM Canada roadside assistance	800-268-6800

## **APPLIANCE WARRANTY**

---

The following are not warranted by Home & Park, but are covered by individual warranties offered by their respective manufacturers to which terms both Purchaser and Dealer must comply: air conditioner, electrical inverter/charger, furnace, generator, microwave oven, range hood exhaust fan, refrigerator, stove, toilet, water pump, water heater, and macerator. Home & Park makes no warranty whatsoever, regarding these items and/or such like components manufactured by others. However, Home & Park will pay for the removal and reinstallation of such components that it determines at its sole discretion are installed by Home & Park in a manner unusual to the industry. **Purchaser and/or Dealer are required to deal directly with the nearest service center for such manufactured components** and abide by the warranty policy as allowed by such component manufacturers. The name, location and phone number of some such component manufacturer's are as follows:

**MANUFACTURER CONTACT INFORMATION:**

Component	Manufacturer	Location	Phone Number
Awning	Fiamma	Orlando, FL	407-672-0091
Battery	Trojan	Santa Fe Springs, CA	800-423-6569
Detector-carbon monoxide	MTI Industries	Wauconda, IL	800-383-0269, 847-487-4940
Detector - Propane	MTI Industries	Wauconda, IL	800-383-0269, 487-487-4940
DVD Player	AVS Technologies	Mississuga, ON	800-303-0287
Flat LCD T.V.	Aralex Acoustics Ltd	Coquitlam BC	306-221-7610
Furnace (U.S.)	Suburban Mfg.	Elkhart, IN	423-775-2131
Furnace (Canada)	Suburban c/o GL Products	Oakville, ON	905-845-7558
Generator (U.S.)	Onan Corporation	Minneapolis, MN	800-888-6626
Generator (Canada)	Onan Corporation	Oakville, ON	905-795-0050
Heat Pump	Dometic	Elkart, IN	800-544-4881
Inverter/Charger	Tripp-Lite	Chicago, IL	773-869-1234
Microwave (U.S.)	Dometic Corporation	Elkhart, IN	800-544-4881, 219-463-4858
Microwave (Canada)	Dometic Distribution	Cambridge, ON	519-653-4390
Oven-Microwave (210)	Camco Inc.	Hamilton	800-361-3400
Refrigerator (U.S.)	Dometic Corporation	Elkhart, IN	800-544-4881, 219-463-4858
Refrigerator (Canada)	Dometic Distribution	Cambridge, ON	519-653-4390
Roof Vent - Power	FanTastic Vent	Capac, MI	810-724-3818
Satellite	MotoSat	Salt Lake City, UT	800-247-7486
Screens (for van doors)	Bug Barrier	Medina, OH	800-548-0214, 216-723-2551
Toilet (U.S.)	Thetford Corporation	Ann Arbor, MI	800-521-3032
Toilet (Canada)	Thetford Sanitation	Mississauga, ON	905-671-0255
Water Heater (U.S.)	Suburban Mfg.	Elkhart, IN	423-775-2131
Water Heater (Canada)	Suburban c/o GL Products	Oakville, ON	905-845-7558
Water Pump (U.S.)	Shurflo	Santa Ana, CA	800-854-3218
Water Pump (Canada)	Shurflo	Belmont, ON	519-727-6752
Wheels - Aluminum(SE)	Prime Wheel	Gardena, CA	310-516-9126
Wheels - Aluminum	American Racing	Mississauga, ON	800-959-1969

**HOME & PARK LIMITED MOTORHOME WARRANTY:**

---

Home & Park warrants to the Purchaser that the Vehicle is free from defects in material and workmanship on the portion manufactured by Home & Park, under normal use and service, for **four (4) years or 48,000 miles** whichever occurs first, from date of purchase by the first Purchaser or the date the Vehicle was first put into service, (for example, as a demo or rental), whichever is earlier.

This warranty shall be fulfilled at a Home & Park Dealer or authorized Roadtrek repair facility. For in transit emergency repairs, you may choose to deal with a non-authorized RV service facility. However **all warranty repairs at non-authorized RV service facilities** must be preauthorized by Home & Park. Home & Park will, at its option, replace or repair free of charge, (including related labor) any defective part, about which the Purchaser shall notify their Roadtrek Dealer within the warranty period. The obligation of Home & Park under this warranty, is expressly limited to such replacement or repair.

The provisions of this limited warranty shall not apply to the following:

1. Accident.
2. Unauthorized repairs or alterations.
3. Normal maintenance.
4. Changes made to other units manufactured after this Vehicle was manufactured.
5. Incidental damages connected with the failure of the Vehicle such as lost time, inconvenience, loss of use of the Vehicle, cost of rental cars, gasoline, telephone, travel or lodging.
6. Damages caused by environmental factors including, but not limited to, hailstorms, tornadoes, sandstorms, lightning, floods, earthquakes, airborne fallout, chemicals, tree sap, ocean spray, road hazards.
7. Vehicle that has been declared a total loss by an insurance company, (demolished) or a Vehicle whose title indicates that it is designated as "salvage," "junk," or "rebuilt" or words of similar impact.
8. Exterior side storage compartments may not be moisture free. It is advised that you store items accordingly. Home & Park is not responsible for goods damaged while stored in exterior storage compartments.
9. There will be no allowance for emergency road repair, towing, labor, meals accommodations, etc. Such will not be accepted if claimed under warranty.
10. After the "QualityCare" Pre-Delivery Report is completed by the dealer, appliance adjustments, door latch adjustments, light bulbs, fuses, battery in the smoke detector and window screens are warranted for 90 days.
11. Aluminum wheels are not warranted against corrosion that is a result of road salt, sea salt, cleaning chemicals or harsh driving conditions.

**HOME & PARK LIMITED MOTORHOME WARRANTY:**

---

The provisions of this limited warranty shall not apply to deterioration due to wear and exposure beyond the following limitations:

1. For **one (1) year** or 12,000 miles (in US) or 20,000 Km (in Canada), which ever occurs first, from date of purchase by the first Purchaser for sewage hose, curtain fabric, seating fabric, carpet, cup holders, exterior stripes and decals, running board trim, and black and grey water tank valves.
2. For **two (2) years** or 24,000 miles (in US) or 40,000 Km (in Canada), which ever occurs first, from the date of purchase by the first Purchaser for leather seats.
3. For **three (3) years** or 36,000 miles (in US) or 60,000 Km (in Canada), which ever occurs first, from date of purchase by the first Purchaser for exterior painted surfaces.

Home & Park Limited Motorhome Warranty is void unless the following conditions are adhered to:

1. Warranty Card on Vehicle must be completed by the Dealer and faxed to Home & Park within 48 hours of date of retail delivery. When warranty applications are made and Warranty Card is not on file at Home & Park, reimbursement of claim will be delayed until proof of original purchase is submitted to Home & Park.
2. All warranty claims must be submitted on a Home & Park Motorhomes Warranty Claim form and properly completed including Vehicle Identification Number (V.I.N.), odometer reading and Home & Park Limited Motorhome Warranty start date (date of retail delivery).
3. **Warranty work that will exceed \$200 must first be authorized by Home & Park** before proceeding with such work. The authorization number issued by Home & Park must be noted on the warranty claim.
4. Home & Park reserves the right to inspect defective parts that have been replaced under warranty. Dealer is expected to hold selected parts for a period of not to exceed 60 days.
5. Only parts and accessories and other material, available through Home & Park are to be used in the performance of warranty service.
6. Warranty repairs performed a second time by a Dealer (due to incorrect or inadequate diagnosis, improper assembly or repair, or lack of proper testing when the original warranty repair was performed) are considered as shop comebacks and are not reimbursable. Costs of such repairs must be adsorbed by the Dealer.
7. All claims must be submitted within 30 days of the date of repair.
8. Purchasers are responsible for presenting their vehicle to a Roadtrek Dealer as soon as a problem exists. The warranty repairs should be completed in a reasonable amount of time from date of authorization.

This limited warranty is expressly in lieu of any other expressed or implied warranty, including any implied warranty of merchantability or fitness for a particular purpose and of any other obligations or liabilities on Home & Park which neither assumes nor authorizes any other person to assume for it any other liability in connection with Vehicle manufactured by it.

## **REPORTING SAFETY DEFECTS (U.S. ONLY)**

---

If you believe that your vehicle has a defect which could cause a crash or could cause injury or death, you should immediately inform the National Highway Traffic Safety Administration (NHTSA) in addition to notifying Home & Park.

If NHTSA receives similar complaints, it may open an investigation, and if it finds that a safety defect exists in a group of vehicles, it may order a recall and remedy campaign. However, NHTSA cannot become involved in individual problems between you, your dealer, or Home & Park.

To contact NHTSA, you may call the Auto Safety Hot line toll-free at 1-800-424-9393 (or 366-0123 in Washington, DC area) or write to:

NHTSA  
U.S. Department of Transportation  
Washington, DC 20590

You can also obtain other information about motor vehicle safety from the Hot line.

## **ROADTREK AMBASSADOR POTENTIAL CUSTOMER REFERRAL PROGRAM FOR ROADTREK OWNERS:**

---

Most Roadtrek owners spend a lot of their valuable time giving tours of their Roadtreks to numerous inquisitive people. Many of these potential customers become Roadtrek owners. To reward their efforts and encourage more "tours" by these very convincing "sales people," we will pay a \$100.00 commission and provide incentive rewards to any Roadtrek owner who refers a potential customer to us who eventually purchases a new Roadtrek

To participate in this program, the Roadtrek owner must sign up for the Roadtrek Ambassador program by visiting [www.roadtrek.com/ambassador](http://www.roadtrek.com/ambassador) or calling 1-888-ROADTREK (762-3873). For every potential customer that you show your Roadtrek, complete a "Potential Customer Referral Card". You will receive \$100.00 for each referral that purchases a new Roadtrek. In addition, we have these complimentary gifts:

1. For your 1st purchasing customer we will send you Two Roadtrek Ambassador Golf Shirts.
2. For your 2nd purchasing customer we will send you Two Roadtrek Ambassador Windbreakers.
3. For your 5th purchasing customer we will send you Two Roadtrek Ambassador Leather & Melton jackets.
4. For your 10th purchasing customer we will provide an all expense paid trip to the Roadtrek factory.

If these incentives weren't enough, all Roadtrek Ambassadors referring more than 2 purchasing customers in a given year will be eligible for a draw to win the use of a new Roadtrek for a full year (mileage restrictions will apply).

This program is subject to the following conditions:

1. Home & Park receives a "Potential Customer Referral Card" (supplies available upon request) completed and mailed by the potential customer and/or Roadtrek owner.
2. The potential customer purchases a new Roadtrek within 3 years from the date the "Potential Customer Referral Card" is received by Home & Park.
3. The potential customer purchases a new Roadtrek and has the dealer complete the "Home & Park Warranty Registration" in the same name and address that was inserted on the "Potential Customer Referral Card".
4. If more than one Roadtrek owner refers the same potential customer, the \$100.00 commission will be split equally among all of the referring Roadtrek owners.

**Home & Park Motorhomes reserves the right to cancel this program based upon 90 days notice to Roadtrek owners.**

## **ROADTREK CLUB INTERNATIONAL**

---

As a new Roadtrek owner, you are cordially invited to join our family of Roadtrek owners as members of the "Roadtrek Club International". An owners' club offers its members an opportunity to meet other people with common interests, attend enjoyable gatherings (such as group outings, sight seeing, camping, suppers, factory tours, and more!), share travel experiences, keep current on the latest information and products from the factory, and exchange ideas for improvements or solutions to problems. Annual membership dues are only US\$10. Their common bond is the that they are all Roadtrek owners. As a group, they promote fellowship and enrich their way of life.

Roadtrek Club International is an active Chapter of the Family Motor Coach Association. FMCA, the foremost organization in the world composed exclusively for motorhome owners, was founded in 1963 for the express purpose of promoting fellowship and the use of motor coaching for pleasure. Many of its 130,000 members meet and form fast friendships with fellow motorhomers and join together in Association sponsored activities that are interesting and fun.

FMCA offers benefits and services specially designed to meet the needs of motorhome owners that you can't get anywhere else. Although space does not permit listing everything available, member benefits include: free monthly subscription to the full color Family Motor Coaching magazine, minimum cost motorhome insurance, accidental death coverage, emergency road service, trip routing service, toll free 800 number message service, mail forwarding, identification emblems for your motorhome, free membership directory, anti-theft program, discount programs, national and regional conventions, caravans and tours, and year-round activities in nearly 300 chapters of FMCA for fun, fellowship and entertainment... plus much more. FMCA dues are \$35 per year plus a one time \$10 initiation fee in the first year.

Just complete the applications on the next page and mail them with your checks to the addresses shown. You'll be glad you did!

## **ADDRESS, PHONE & FACSIMILE NUMBERS, AND E-MAIL**

---

Address all inquiries to: Home & Park Motorhomes  
Warranty & Service Department  
100 Shirley Avenue  
Kitchener, Ontario, Canada, N2B 2E1  
Telephone: toll free 888-ROADTREK (762-3873) or 519-745-1169  
Facsimile: 519-745-1160  
E-mail: [service@roadtrek.com](mailto:service@roadtrek.com)

All inquiries must include: Owner's name, address, home and work phone numbers  
Selling Home & Park dealer's name and contact  
Servicing Chevrolet dealer's name, contact and phone number  
(if applicable)  
Last 8 digits of Vehicle Identification Number (V.I.N.)  
Vehicle mileage  
Date of Retail Delivery

## **WEBSITE**

---

Checkout the Roadtrek website at [WWW.roadtrek.com](http://WWW.roadtrek.com)

## OBTAINING MOTORHOME SERVICE

The solution to all your Roadtrek concerns starts with your Roadtrek Dealer

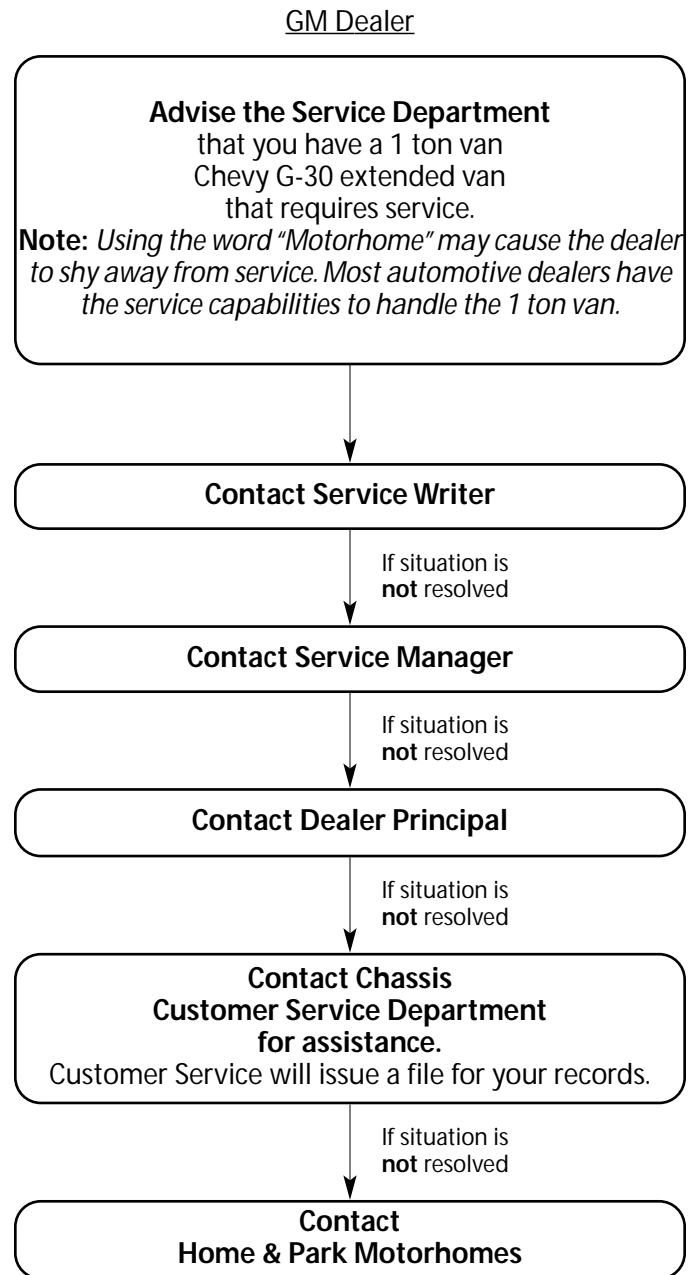
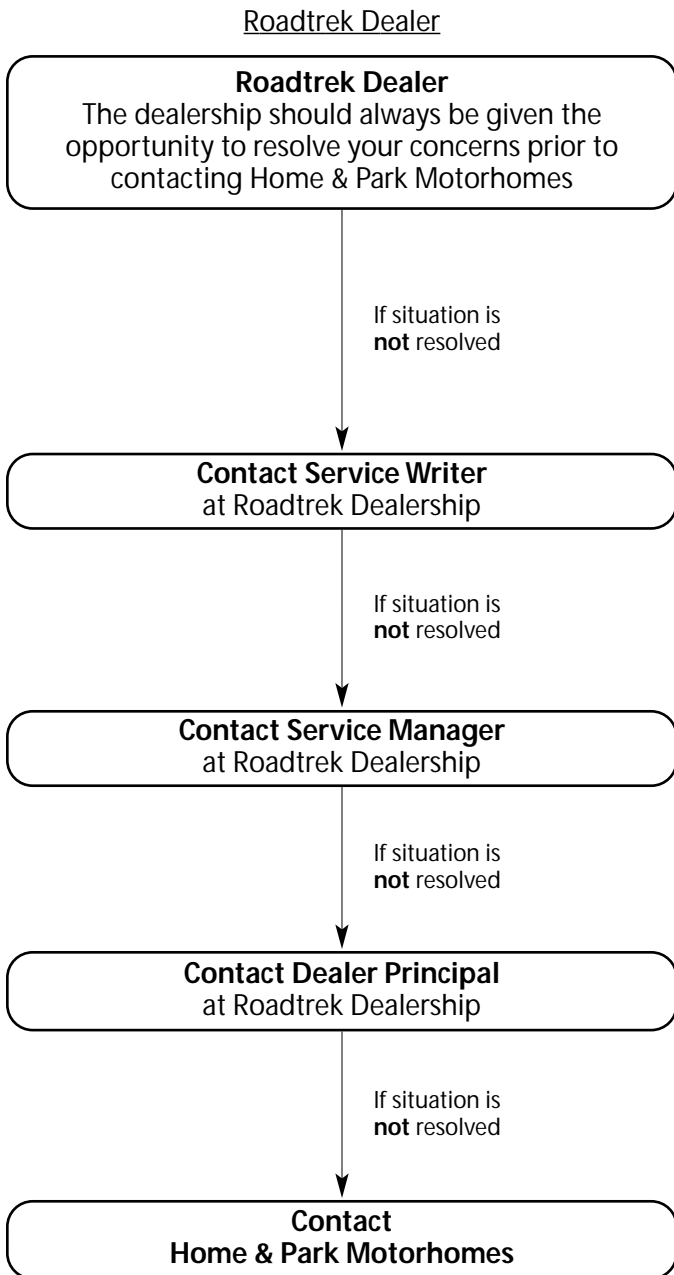









## CHANGE OF OWNER NAME OR ADDRESS FORM

IMPORTANT - To owner with New Address or Used-Vehicle Buyer - complete and mail for accuracy of recall mailing records.

PLEASE TYPE OR PRINT LEGIBLY:

1. VEHICLE IDENTIFICATION NUMBER (17 character number found on top left of instrument panel)									
2. PRINT Last Name (including Jr., Sr., etc.)									
3. PRINT First Name (or Initial) and Middle Name (or Initial)									
4. PRINT NEW mailing Address: House/Building Number and Street Name (including St., Ave., Rd., Ct., etc.)									
Apt./Suite No.		or	P.O. Box No.			or <input type="checkbox"/> RRR/ <input type="checkbox"/> HCR (check one)		<input type="checkbox"/> RR/ <input type="checkbox"/> HCR Box No.	
City			State		ZIP Code		ZIP + 4		
Area Code			Prov.		Postal Code				
Phone No.		Month	Day	Year		Email Address			
Current Date		Month	Day	Year		Email Address			
									
<small>Form 2, February 1999 M190204</small>									



\_\_\_\_\_  
\_\_\_\_\_  
\_\_\_\_\_  
\_\_\_\_\_

**AFFIX  
STAMP**

 **Roadtrek**™®  
100 SHIRLEY AVENUE  
KITCHENER, ONTARIO  
N2B 2E1



## POTENTIAL CUSTOMER REFERRAL CARD

PLEASE TYPE OR PRINT LEGIBLY:

PRINT **Potential Customer Name** (including Jr., Sr., etc.)

---

PRINT **Mailing Address:** House/Building Number and Street Name (including St., Ave., Rd., Ct., etc.)

City State/Prov. ZIP/P.C.

---

Country Email

---

Please send me a brochure and the name and address of my nearest dealer

Area Code Phone No. -

**REFERRED BY:**

Roadtrek Vehicle Identification Number (last 8 digits only) Email

---

PRINT **Roadtrek Owner's Name** (including Jr., Sr., etc.)

---

PRINT **Mailing Address:** House/Building Number and Street Name (including St., Ave., Rd., Ct., etc.)

City State/Prov. ZIP/P.C.

---

Please send me more of these referral cards  Please send me more brochures





## POTENTIAL CUSTOMER REFERRAL CARD

PLEASE TYPE OR PRINT LEGIBLY:

PRINT **Potential Customer Name** (including Jr., Sr., etc.)

---

PRINT **Mailing Address:** House/Building Number and Street Name (including St., Ave., Rd., Ct., etc.)

City State/Prov. ZIP/P.C.

---

Country Email

---

Please send me a brochure and the name and address of my nearest dealer

Area Code Phone No. -

**REFERRED BY:**

Roadtrek Vehicle Identification Number (last 8 digits only) Email

---

PRINT **Roadtrek Owner's Name** (including Jr., Sr., etc.)

---

PRINT **Mailing Address:** House/Building Number and Street Name (including St., Ave., Rd., Ct., etc.)

City State/Prov. ZIP/P.C.

---

Please send me more of these referral cards  Please send me more brochures





\_\_\_\_\_  
\_\_\_\_\_  
\_\_\_\_\_  
\_\_\_\_\_

**AFFIX  
STAMP**

 **Roadtrek™**  
100 SHIRLEY AVENUE  
KITCHENER, ONTARIO  
N2B 2E1



\_\_\_\_\_  
\_\_\_\_\_  
\_\_\_\_\_  
\_\_\_\_\_

**AFFIX  
STAMP**

 **Roadtrek™**  
100 SHIRLEY AVENUE  
KITCHENER, ONTARIO  
N2B 2E1

Please contact Home & Park Motorhomes should you require additional customer referral cards.





Division of HANMAR MOTOR CORPORATION  
100 Shirley Avenue, Kitchener, Ontario,  
Canada, N2B 2E1  
Telephone: 519-745-1169  
or Toll Free 1-888-ROADTREK (1-888-762-3873)  
Telefacsimile: 519-745-1160  
Email: [service@roadtrek.com](mailto:service@roadtrek.com)  
WebSite: <http://www.roadtrek.com/LIT>